

## ➔ SERIES 1670 - SINGLE AND DOUBLE-POLE PUSHBUTTON SWITCHES

TO 16 (4) A 250 V AC



### PRODUCT FEATURES

- ➔ Illuminated and non-illuminated pushbutton switch
- ➔ Internal gasket for IP 54
- ➔ Proven jump contact switching system (double interrupting)
- ➔ Opening and closing speed independent of the actuating speed
- ➔ Product-dependent with external lamp terminal

### ON REQUEST



- ➔ Other colors
- ➔ Other printing variants
- ➔ Other terminal types
- ➔ Other lamp variants
- ➔ Cable assembly
- ➔ Approval mark UL



<b>Mechanical life endurance</b>	5E4 1E4
<b>Operating force</b>	approx. 8 N
<b>Contact resistance (new condition)</b>	< 100 mOhm (1 A 12 V DC)
<b>Insulation resistance (new condition)</b>	> 100 MOhm (500 V DC)
<b>Proof tracking</b>	250 PTI
<b>Protection type</b>	IP 54
<b>Ambient temperature</b>	terminal side -20 °C ... +85 °C actuating side -20 °C ... +55 °C
<b>Flammability</b>	UL 94 V-2
<b>Glow wire test temperature</b>	850 °C
<b>Material</b> actuator housing terminals	PC (product-dependent) / PA PA / PA glass fiber-reinforced (product-dependent) Cu
<b>Plug force of the terminals</b>	≤ 80 N
<b>Approval marks</b>	
<b>Suitable for appliances of protection class II</b>	



# SERIES 1670 - SINGLE AND DOUBLE-POLE PUSHBUTTON SWITCHES

TO 16 (4) A 250 V AC

  single-pole	Lighting voltage (V)	Actuator color / printing	Housing color	16 (4) A 250 V AC 1E4	12 (4) A 250 V AC 1E4	Terminal type	Terminal description	Contact distance (mm)	Contact material	Miscellaneous	Stock version
<b>Normally open contact (SPNO)</b>											
1675.5315	230						6.3 / 2 x 4.8	≥ 3	Ag	external lamp terminals	
1672.5101							6.3	≥ 3	Ag		
<b>Changeover switch (SPDT)</b>											
1673.5501							4.8	< 3	Ag		







  double-pole	Lighting voltage (V)	Actuator color / printing	Housing color	16 (4) A 250 V AC 1E4	12 (4) A 250 V AC 1E4	Terminal type	Terminal description	Contact distance (mm)	Contact material	Miscellaneous	Stock version
<b>ON / OFF switch (DPST)</b>											
1670.5201	230						6.3	≥ 3	Ag		
1670.5202	230						6.3	≥ 3	Ag		
1670.5204	230						6.3	≥ 3	Ag		
1670.5203	115 - 230						6.3	≥ 3	Ag		
1671.5201							6.3	≥ 3	Ag		
1671.5203							6.3	≥ 3	Ag		
<b>Normally open contact (DPNO)</b>											
1671.5101							6.3	≥ 3	Ag		

ROTARY SWITCHES  
 PUSHBUTTON SWITCHES  
 TOGGLE SWITCHES  
 SLIDE SWITCHES  
 ROTARY SWITCHES  
 FOOT SWITCHES  
 TACT AND KEY SWITCHES  
 MICRO-SIGNAL SWITCHES  
 SMIP-ACTION SWITCHES  
 SENSORS  
 ECO  
 PUSH IN DRIVE



# SERIES 1670 - SINGLE AND DOUBLE-POLE PUSHBUTTON SWITCHES

TO 16 (4) A 250 V AC

 Lamp	Lighting voltage (V)	Actuator color / printing	Housing color	16 (4) A 250 V AC 1E4	12 (4) A 250 V AC 1E4	Terminal type	Terminal description	Contact distance (mm)	Contact material	Miscellaneous	Stock version
	1677.5306	230					6.3				
1677.5308	115 - 230					6.3					



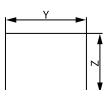

Basic types 1672, 1673 and 1675 single-pole illuminated / non-illuminated



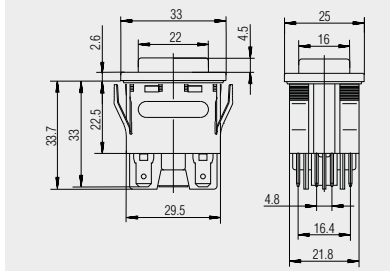

X = Wall thickness

x	y	z
0.8 ... 5.0	30 <sup>+0.15</sup>	22.2 <sup>+0.15</sup>
0.8 ... 5.0	30 <sup>+0.15</sup>	22.2 <sup>+0.15</sup>

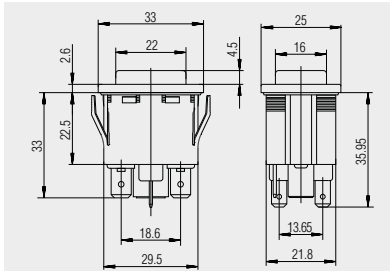

 Quick-connect terminal 4.8 x 0.8  
1673.5501



 Quick-connect terminal 6.3 x 0.8 / 2 x 4.8 x 0.8 external lamp terminal  
basic type 1675

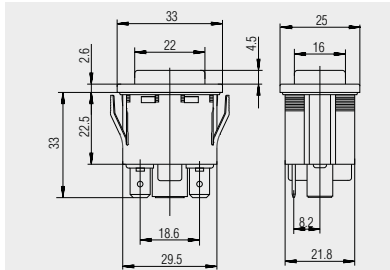

 Quick-connect terminal 6.3 x 0.8  
basic type 1672

ROCKER SWITCHES

PUSHBUTTON SWITCHES

TOGGLE SWITCHES

SLIDE SWITCHES

ROTARY SWITCHES

FOOT SWITCHES

TACT AND KEY SWITCHES

SNAP-ACTION SWITCHES

MICRO-SIGNAL SWITCHES

SENSORS

ECO

PUSH/DRIVE



# SERIES 1670 - SINGLE AND DOUBLE-POLE PUSHBUTTON SWITCHES

TO 16 (4) A 250 V AC



Basic types 1670 and 1671  
double-pole  
illuminated / non-illuminated

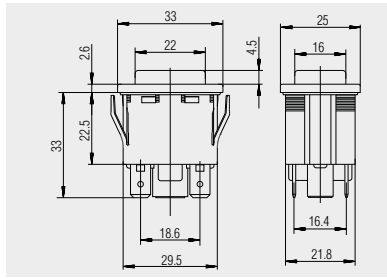

Quick-connect terminal 6.3 x 0.8

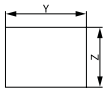

X = Wall thickness

x	y	z
0.8 ... 5.0	30 <sup>+0.15</sup>	22.2 <sup>+0.15</sup>



Basic type 1677  
lamp

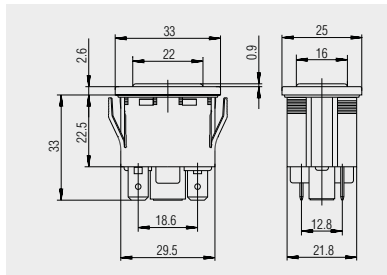

Quick-connect terminal 6.3 x 0.8

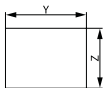

X = Wall thickness

x	y	z
0.8 ... 5.0	30 <sup>+0.15</sup>	22.2 <sup>+0.15</sup>



Dummy piece  
203.020.013

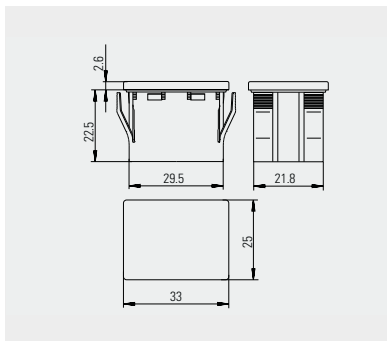

Dummy piece for size of basic type 1677 made of PA with housing in black and cover in blue

ROCKER SWITCHES  
PUSHBUTTON SWITCHES  
TOGGLE SWITCHES  
SLIDE SWITCHES  
ROTARY SWITCHES  
FOOT SWITCHES  
TACT AND KEY SWITCHES  
SNAP-ACTION SWITCHES  
MICRO-SIGNAL SWITCHES  
SENSORS  
ECO  
PUSH-IN DRIVE

# MARQUARDT INTERNATIONAL.



## HEADQUARTERS

### Marquardt Mechatronik GmbH

Schloss-Straße 16  
78604 Rietheim-Weilheim / GERMANY  
Tel. +49 (0)74 24/99-0  
Fax +31 (0)74 24/99-2399  
marquardt@marquardt.com  
[www.marquardt.com](http://www.marquardt.com)



## DISTRIBUTOR

### GEUKEN B.V.

Wattstraat 25a  
2723 RA Zoetermeer / NETHERLANDS  
Tel. +31 (0)79 361 60 70  
Fax +31 (0)79 361 40 90  
info@geuken.nl  
[www.geuken.nl](http://www.geuken.nl)