

micro



A.A.G.
STUCCHI



Arclightstudio

Esempi di applicazione della gamma **micro** e SENZAFINE flat in contesto home.
*Home application example of **micro** range and SENZAFINE Flat.*

UN SISTEMA COMPLETO

A COMPLETE SYSTEM

Micro è un **sistema completo** di binari, adattatori, adattatori per il controllo della luce e connessioni a scomparsa, adatti ad ideare progetti di illuminazione dinamici, minimal ed eleganti.

Micro is a **complete system** with tracks, adapters, adapters for light control and concealed connections, ideal to create dynamic, minimal and elegant lighting installations.

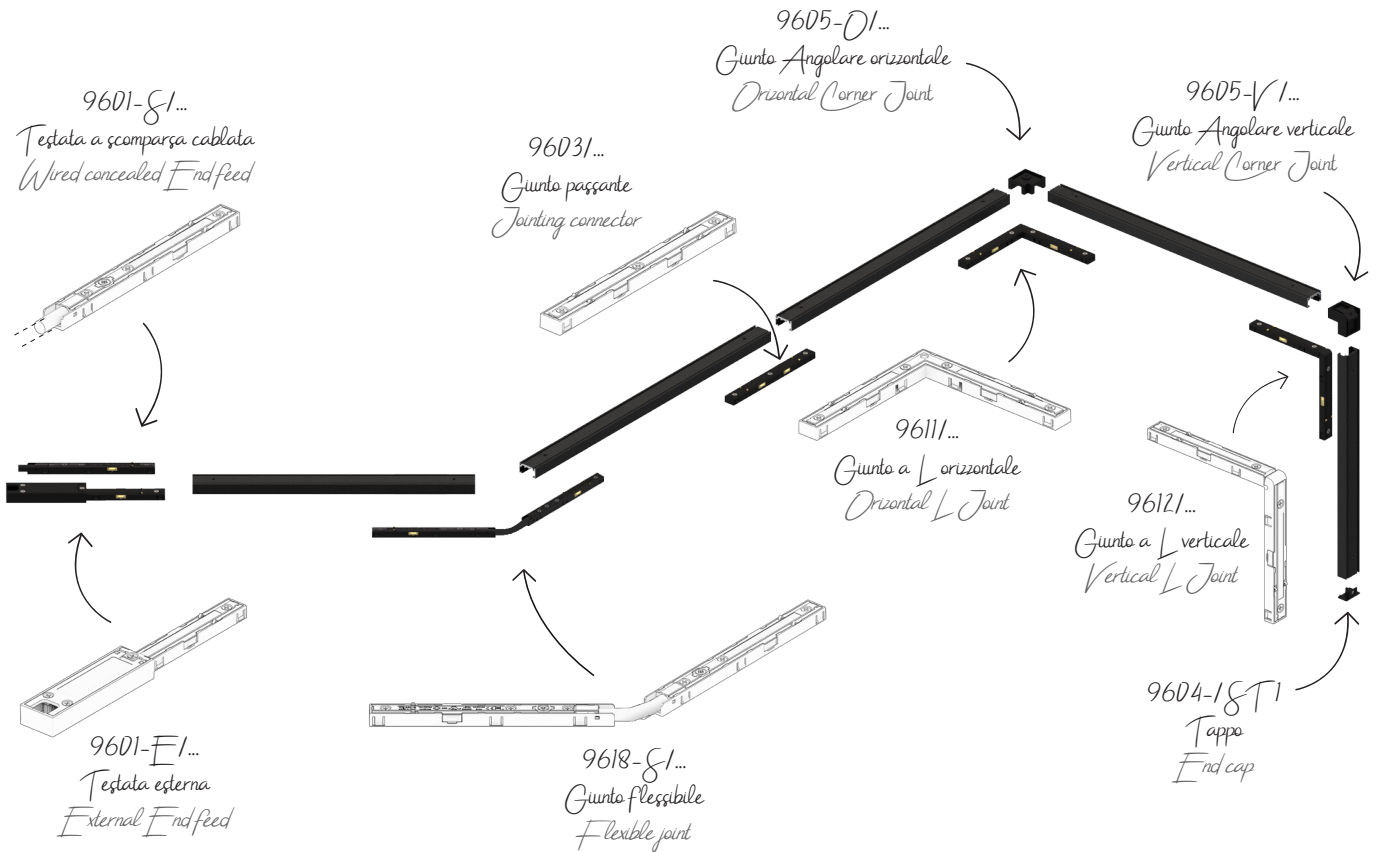

ADATTATORE

ADAPTER

L'adattatore prevede l'inserimento di drivers con **appositi contatti A.A.G. Stucchi** integrati.

The adapter is meant for insertion of drivers with **custom A.A.G. Stucchi contacts** integrated on it.



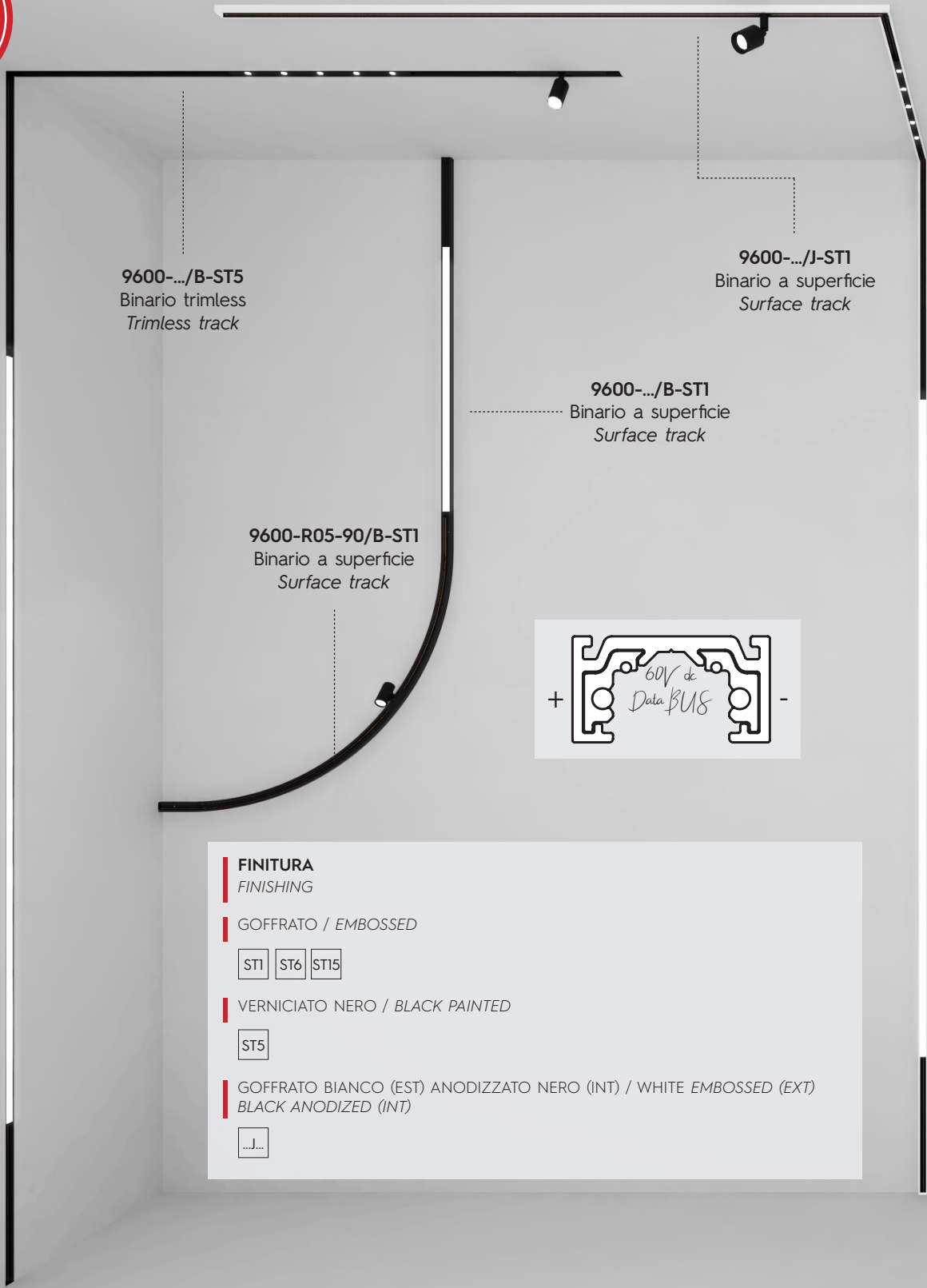

FINITURA
FINISHING

GOFFRATO / EMBOSSED

ST1 ST6 ST15

VERNICIATO NERO / BLACK PAINTED

ST5

GOFFRATO BIANCO (EST) ANODIZZATO NERO (INT) / WHITE EMBOSSED (EXT)
BLACK ANODIZED (INT)

...J...

Micro è la famiglia di prodotto A.A.G. Stucchi a bassa tensione che nasce per **far fronte all'esigenza di miniaturizzazione** dei componenti e delle strutture emersa dal mercato. Massima attenzione quindi alle **dimensioni, estremamente ridotte**, per avere un prodotto in grado di fare la differenza in contesti dove l'estetica e la cura dei dettagli sono fondamentali.

La gamma **micro** offre diverse tipologie di binario per dare la massima flessibilità ai progetti di illuminazione. Come già per le altre famiglie a bassa tensione, tutti i binari sono progettati sulla base di un **"cuore smart"**, che li rende tecnicamente all'avanguardia grazie al **DATABUS integrato** per il controllo della luce ed allo stesso tempo garantisce **libertà e flessibilità di design** perché costituisce la base per lo sviluppo di **profili customizzati** nella forma ma compatibili con il sistema ed i suoi componenti.

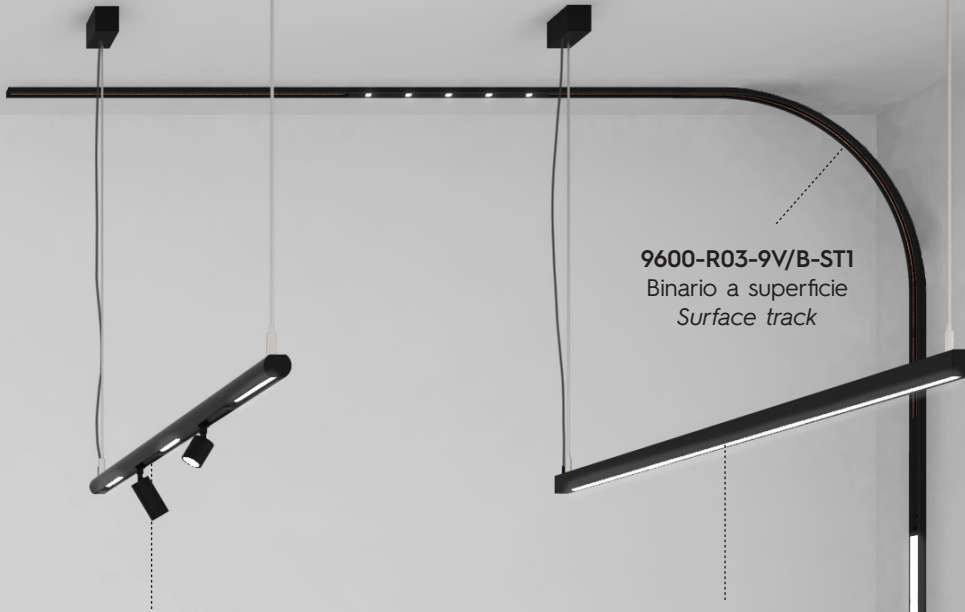

9600-.../B-ST15
Binario a doppia emissione
Double emission track

9600-R03-9V/B-ST1
Binario a superficie
Surface track

9600-.../B-ST6
Binario a doppia emissione
Double emission track

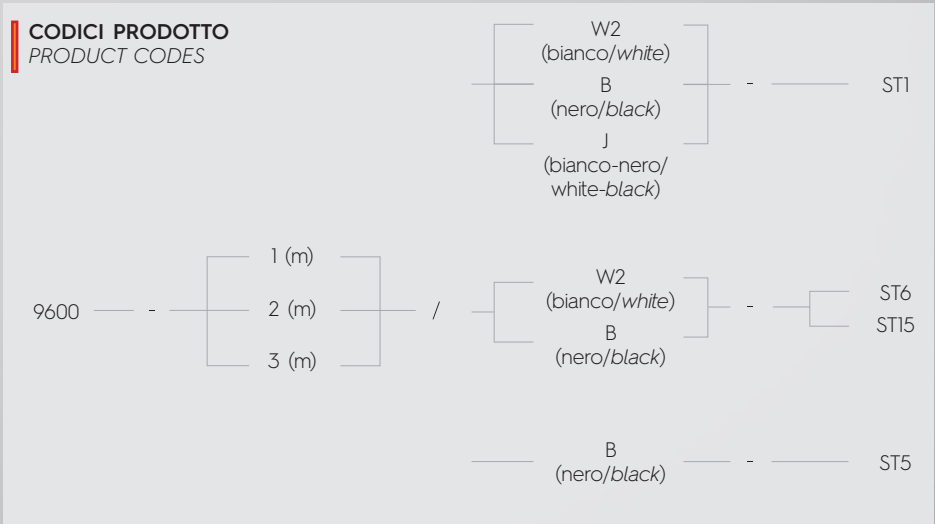

Micro is the new A.A.G. Stucchi low-voltage product family born to meet the market's need of component and structure **miniaturization**. A great focus has been placed on the **dimensions**, that are **greatly reduced**. Resulting in a product that can make a difference in lighting projects where aesthetics and attention to detail are fundamental.

micro range offers different track profiles to give the maximum flexibility to lighting projects. As with the other low voltage families, all the tracks have the same "smart core". This "smart core" with **integrated DATABUS** for light control, makes it technically at the cutting edge. At the same time it provides **freedom and flexibility in design** as it is the base for developing **customized profile tracks**, maintaining compatibility with the system.

COME SCEGLIERE IL TUO BINARIO
 HOW TO CHOOSE THE TRACK YOU NEED

BINARI A SUPERFICIE/SOSPESI
 SURFACE/SUSPENDED TRACKS

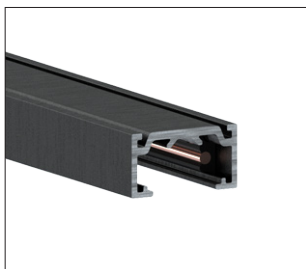

9600-.../B-ST1
 9600-.../W2-ST1

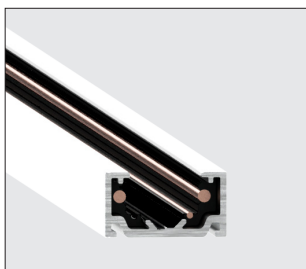
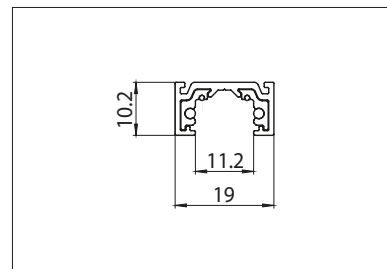

9600-.../J-ST1

Binario a colorazione esterna bianca / interna nera
 Painted track external white / internal black

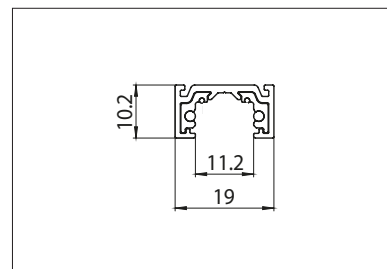

9600-R03-90/B-ST1
 9600-R03-90/W2-ST1

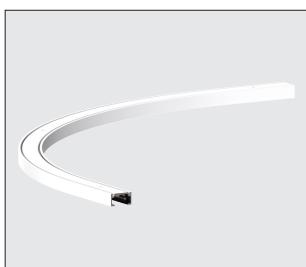
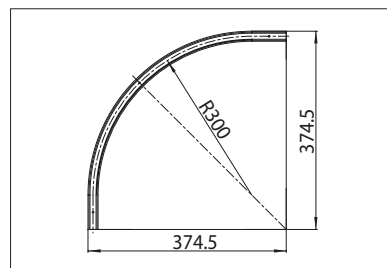

9600-R03-90/J-ST1

Binario a colorazione esterna bianca / interna nera
 Painted track external white / internal black

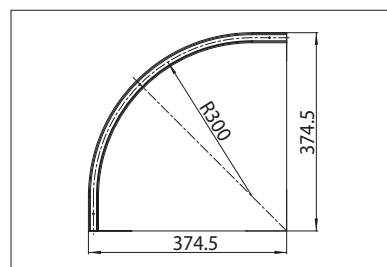

9600-R05-90/B-ST1
 9600-R05-90/W2-ST1

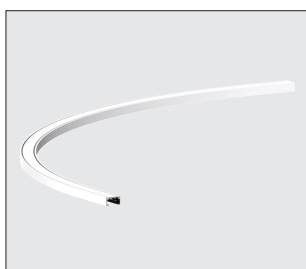
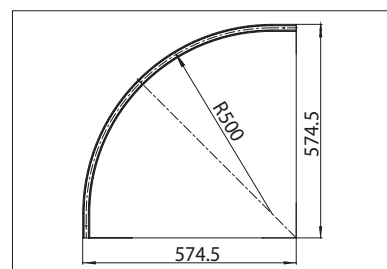

9600-R05-90/J-ST1

Binario a colorazione esterna bianca / interna nera
 Painted track external white / internal black

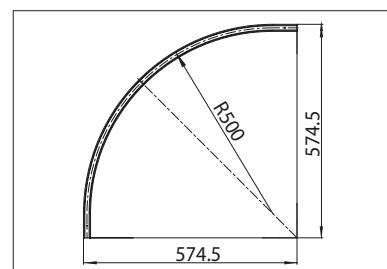



9600-R03-9V/B-ST1
9600-R03-9V/W-ST1

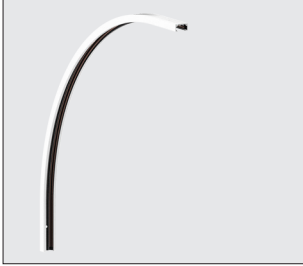
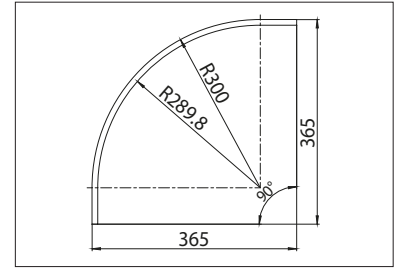

9600-R03-9V/J-ST1 Binario a colorazione esterna bianca / interna nera
Painted track external white / internal black

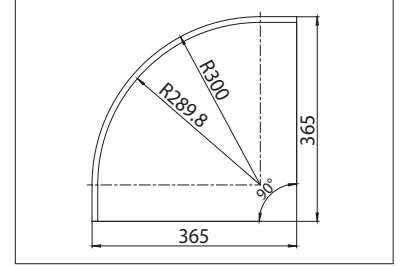

BINARI ROUND
ROUND TRACKS

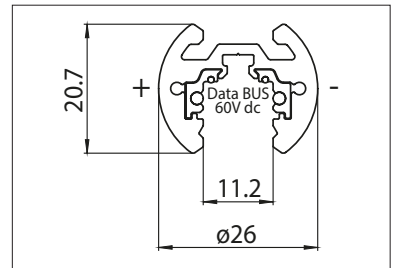

BINARI TRIMLESS
TRIMLESS TRACK



9600-.../B-ST5

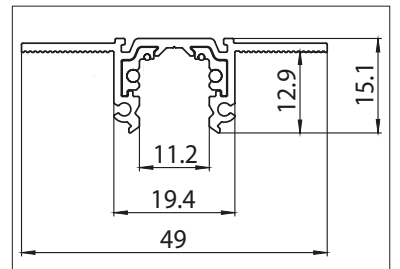

BINARI A DOPPIA EMISSIONE
DOUBLE EMISSION TRACKS

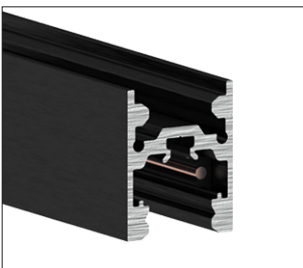

9600-.../B-ST6
9600-.../W2-ST6

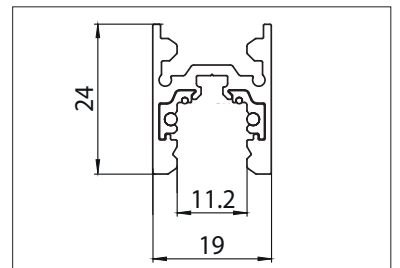

ACCESSORI PER BINARIO

TRACK ACCESSORIES

Per binario:
For track:

ST1

ST5

ST6

ST15

Colori disponibili:
Available colours:

W

bianco
white

RAL 9010

W2

bianco
white

RAL 9016

B

nero
black

RAL 9005

a superficie/sospeso
surface/suspended

trimless

doppia emissione
double emission

round
round



9604/ST1...

Tappo di chiusura in plastica
Plastic end cap

W

B

ST1



9604/ST5...

Tappo di chiusura in plastica
Plastic end cap

W

B

ST5



9604/ST6-B

Tappo di chiusura in plastica
Plastic end cap

W

B

ST6

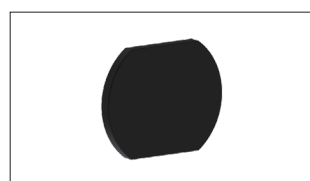

9604/ST15-B

Tappo di chiusura in plastica
Plastic end cap

W

B

ST15

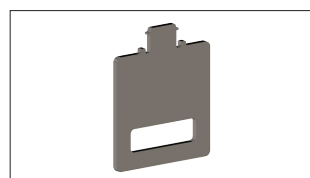

S-9600/DI-ST5

Dima per installazione binario
Template for track installation



ST5

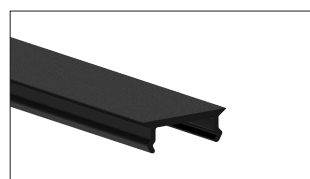

S-9600/...-E-3000

Cover di chiusura estetica (lunghezza: 3m)
Aesthetic track cover (length: 3m)

W2

B

ST5

ST6

ST15

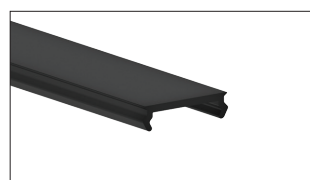

S-9600/...-E1-3000

Cover di chiusura estetica (lunghezza: 3m)
Aesthetic track cover (length: 3m)

W2

B

ST1



S-9600/OP-3000

Schermo opalino $T_L=56\%$
Opal screen $T_L=56\%$

ST5

ST6

ST15

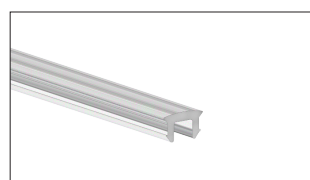

S-9600/S-OP-3000

Schermo opalino $T_L=75\%$ per scheda down-light
Opal screen $T_L=75\%$ for down light led board

ST6

ST15

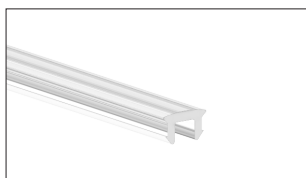

S-9600/S-TR-3000

Schermo trasparente per scheda down-light
Transparent screen for down light led board

W2 B

ST6

ST15

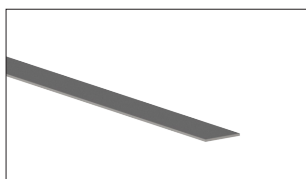

S-9600/MP-3000

Supporto Led per down-light
Led support for down light

ST6

ST15

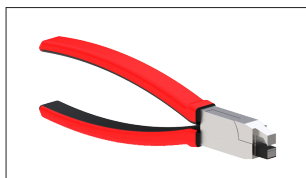

S-9600/T

Tronchese per bloccaggio PVC in caso di taglio binario
Locking tool for PVC to be used in case of track cutting

ST...

ACCESSORI PER IL FISSAGGIO DEL BINARIO TRACK FIXING ACCESSORIES

BINARIO ST15 ST15 TRACK

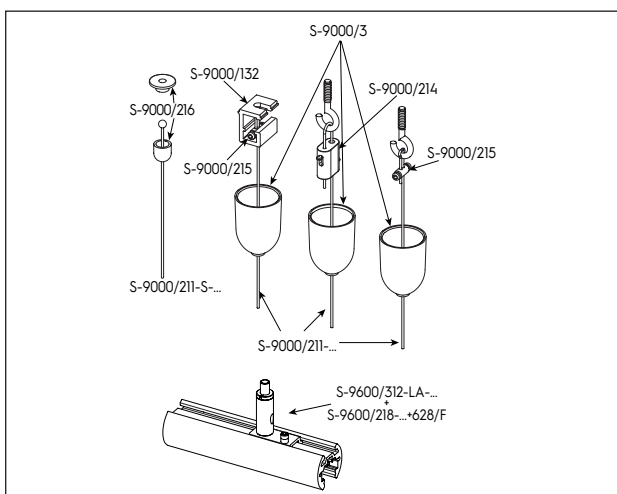

Accessori per sospensione con regolazione a binario
Suspension accessories with track adjustment

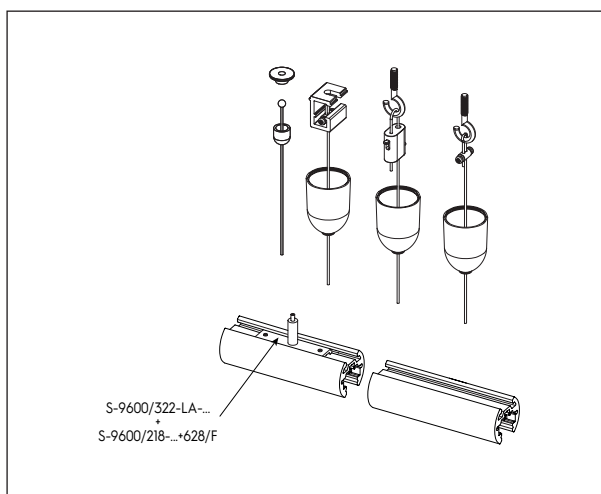

Accessori per giunzioni in fila continua
Accessories for "in row" use junctions

BINARIO ST6 ST6 TRACK

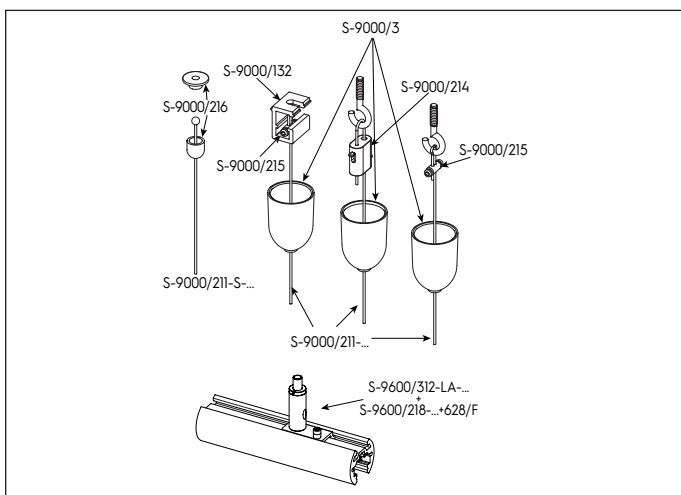

Accessori per sospensione con regolazione a binario
Suspension accessories with track adjustment

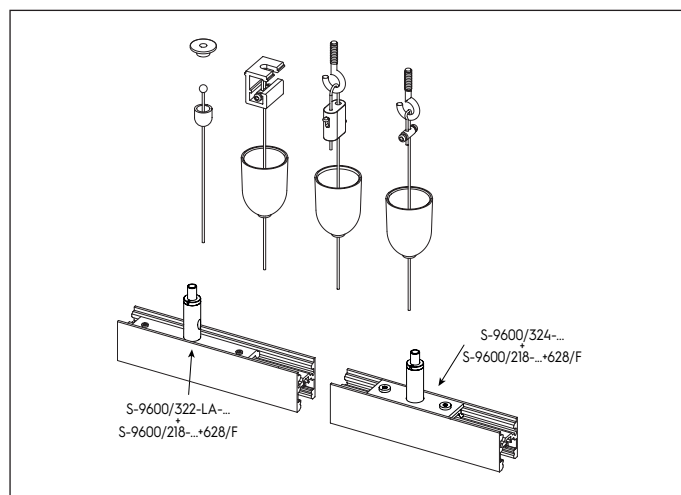

Accessori per giunzioni in fila continua
Accessories for "in row" use junctions

ACCESSORI SINGOLI PER IL FISSAGGIO DEL BINARIO

TRACK FIXING SINGLE ACCESSORIES

Per binario:
For track:

ST1

a superficie/sospeso
surface/suspended

ST5

trimless

ST6

doppia emissione
double emission

ST15

round
round

Colori disponibili:
Available colours:

W

bianco
white

RAL 9010

W2

bianco
white

RAL 9016

B

nero
black

RAL 9005

alluminio grezzo
raw aluminium

ROSONI

CUPS

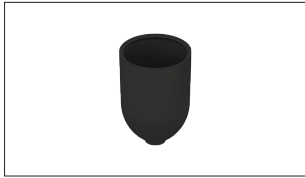

S-9000/3-...

Rosone plastico per filo in acciaio Ø 1.5mm
Plastic cup for steel cable Ø 1.5mm

W

B

ST6

ST15



S-9000/216

Rosone in ottone cromato per fissaggio a soffitto
Chrome plated brass round head ceiling



ST6

ST15

STAFFE PER FISSAGGIO A PLAFONE

CEILING FIXING BRACKET

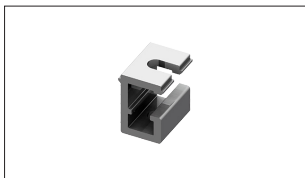

S-9000/132

Staffa per fissaggio a plafone per sospensioni
Ceiling bracket for suspensions



ST6

ST15

STAFFE

BRACKETS



S-9600/312-LA-...

Staffa corta per sospensioni
Short bracket for suspensions

W2

B

ST6

ST15



S-9600/322-LA-...

Staffa lunga per sospensioni
Long bracket for suspensions

W2

B

ST6

ST15



S-9600/324-...

Staffa lunga per sospensioni
Long bracket for suspensions

W2

B

ST6

CAVI

CABLES



S-9000/211-...

Filo in acciaio ø1,5mm
Steel cable ø 1,5mm
(...=L: 1,5/3/5m)



ST...



S-9000/211-S-...

Filo in acciaio con terminale a sfera $\varnothing 1,5\text{mm}$
 Steel cable with spherical end $\varnothing 1,5\text{mm}$
 (...=L: 1,5/3/5m)



ST...

TENDITORI GRIPPERS



S-9000/214

Tenditore automatico
 Automatic lock



ST...



S-9000/215

Tenditore a vite
 Screw gripper



ST...



S-9600/218

Tenditore automatico M3 con foro laterale (da usare con vite 628/F fornita separatamente)
 Automatic M3 threaded gripper with side hole (to be used with 628/F screw supplied separately)



ST...



628/F

Vite per bloccaggio tirante sulla staffa
 Set screw for gripper on the bracket



ST...

BOX DRIVER BOX DRIVER

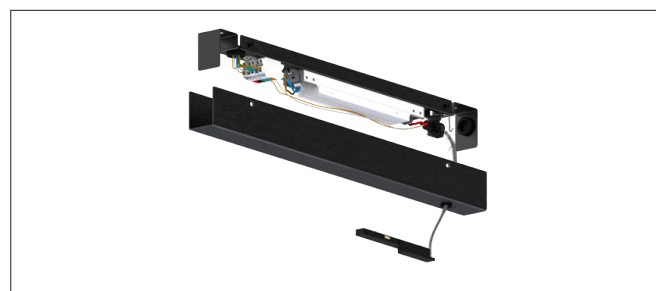
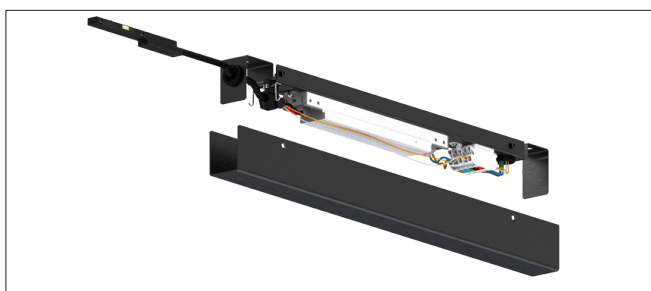

9600/P-100E-...-C1-N

Composto da:

- staffa per fissaggio a soffitto
- alimentatore 230Vac/48Vdc 100W SELV
- testata di alimentazione
- cavo di alimentazione testata (20mm)
- rosone metallico

Includes:

- ceiling bracket
- driver 230Vac/48Vdc 100W SELV
- end-feed
- end-feed power wire (20mm)
- metallic cup

W2 B

Goffrato
 Embossed

ST1 ST5

9600/P-100E-...-SP-N

Composto da:

- staffa per fissaggio a soffitto
- alimentatore 230Vac/48Vdc 100W SELV
- testata di alimentazione
- cavo di alimentazione testata (2000mm)
- rosone metallico

Includes:

- ceiling bracket
- driver 230Vac/48Vdc 100W SELV
- end-feed
- end-feed power wire (2000mm)
- metallic cup

W2 B

Goffrato
 Embossed

ST6 ST15

ADATTATORI ADAPTERS

Verfügbare Farben: **B** Schwarz
Available colours: **B** black



9609/B

Adattatore meccanico snodato per faretto singolo da utilizzare nel binario curvo
Mechanical single spot adapter flexible for use in curved tracks

B

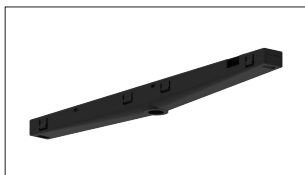

9619-M/B

Adattatore meccanico per faretto singolo
Mechanical single spot adapter

B



9620/B

Adattatore per connessione elettrica schede LED
Adapter for LED board electrical connection

B



9629/B

Adattatore per doppio faretto
Double spot adapter

B

ACCESSORI DEGLI ADATTATORI ADAPTERS ACCESSORIES

Colori disponibili: **B** nero
Available colours: **B** black



S-9619/M6-B

Kit di rotazione M6 per 9629/B
M6 rotation kit for and 9629/B

B



S-9619-M/M6-B

Kit di rotazione M6 per 9619-M/B
M6 rotation kit for 9619-M/B

B

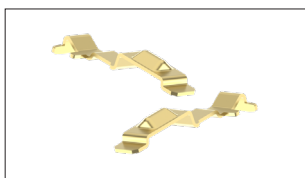

S-9619/41
S-9619/42

Contatti per adattatore
Contacts for adapters



S-9619-D/42

Contatti per adattatore
Contacts for adapters

CONNESSIONI CONNECTIONS

Colori disponibili: **B** nero
Available colours: **B** black



9601-E/B

Testata di alimentazione
End feed

B



9601-S/B

Testata di alimentazione a scomparsa con cavo (L: 2500mm)
Concealed end-feed with wire (L: 2500mm)

B



9603/B

Giunto passante
Jointing connector

B



9611/B

Giunto a L
L joint

B



9612/B

Giunto a L soffitto-parete
L feed ceiling-wall

B



9618-S/B

Giunto flessibile
Adjustable corner

B

ACCESSORI DELLE CONNESSIONI CONNECTIONS ACCESSORIES

Per binario:
For track:

ST1

a superficie/sospeso
surface/suspended

Colori disponibili: **W2** bianco
Available colours: **W2** white

B nero
black

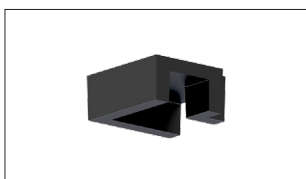

9605-O/...

Coprigiunto angolare orizzontale
Horizontal corner joint cover

W2

B

ST1

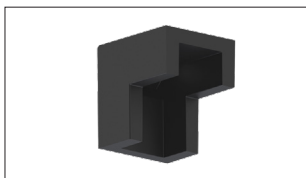

9605-V/...

Coprigiunto angolare verticale
Vertical corner joint cover

W2

B

ST1

Il distributore ha l'obbligo di informare l'utente sulle modalità di utilizzo di tutti i componenti forniti.

Materiali, disegni, programma di fabbricazione e confezioni possono subire modifiche o variazioni senza obbligo di preavviso.

Si declina ogni responsabilità per eventuali errori di stampa.

Tutte le operazioni devono essere eseguite da personale specializzato, escludendo tensione dall'impianto e rispettando le norme nazionali di installazione. Il costruttore permette solo l'utilizzo dei suoi componenti all'interno delle applicazioni che utilizzano il sistema **micro**. Questi componenti devono essere installati secondo le istruzioni di montaggio fornite dall'azienda. L'azienda, come produttrice, non è responsabile della sicurezza e del funzionamento del sistema **micro** in caso si utilizzino componenti non appartenenti ad esso o se le istruzioni di montaggio non venissero rispettate. È inoltre responsabilità del produttore di terze parti utilizzate e/o sviluppate per il sistema **micro** (es. driver/apparecchi di illuminazione) garantirne il corretto funzionamento e la compatibilità elettrica, elettromagnetica, elettronica, meccanica con il sistema stesso. Il binario ed i suoi componenti, compresi gli adattatori, non sono intercambiabili con accessori che non riportino il Marchio di Qualità. Sul binario **micro** è possibile utilizzare solo le connessioni **micro**. Le connessioni **micro** possono essere utilizzate solo su binari **micro**. Questo sistema a binario in classe III, non è compatibile con sistemi a binario in classe I o in classe III di altri costruttori. Inserire sul circuito di alimentazione le opportune protezioni affinché siano prevenuti eventuali sovraccarichi o cortocircuiti.

AVVERTENZE

- È vietato utilizzare alimentatori, driver, sistemi Bus Dati e componenti non omologati SELV e/o che abbiano una U-OUT maggiore di 60 V dc

- Il costruttore raccomanda l'utilizzo di un ripetitore optoisolato (es. S-RP-24-48V)

In caso fosse necessario all'interno della stessa installazione (edificio, negozio etc) creare un unico Bus Data unendo elettricamente il Bus Dati del binario a bassa tensione con quello di altri apparecchi di illuminazione è necessario che tutti i componenti utilizzati siano classificati SELV.

- È severamente vietato utilizzare qualsiasi tipo di solvente, colla, olio, sgrassatore o detergente a contatto con tutti i componenti del sistema **micro**.

L'azienda non è responsabile di eventuali danni causati dall'utilizzo di suddetti materiali.

INFORMAZIONI TECNICHE

- Tensione (in entrata): 0 - 60 V dc

- Corrente: max. 10A - 1A bus dati

- T massima di funzionamento: 70°C (Ta 25°C)

-  Classe III (SELV)

- Cavi per cablaggio testata: 2xAWG16 + 2xAWG22

- Certificazione UL 48V-2A Class 2 - 1A bus dati

- Peso massimo dell'apparecchio di illuminazione: 5N con adattatore

- Binari per utilizzo in versione NON polarizzata

- Componenti plastici disponibili solo nella versione NON polarizzata

- Usare solo elettroniche NON polarizzate

- Nelle curve NON vanno inseriti gli adattatori. Unica eccezione l'adattatore 9609 che può essere inserito nelle sole curve orizzontali con raggio maggiore di 300 mm.

- ATTENZIONE: per limitare il rischio di surriscaldamento e di incendio non cortocircuitare i conduttori

- La sostituzione del cavo della testata 9601-I/... può essere effettuata solo dal costruttore o dal suo servizio di assistenza

The distributor is obliged to provide its customers with guidance on the correct use of all components supplied.

Materials, designs, our development program and packages may be subjected to changes without notice.

We decline all responsibility for any misprint.

*All the operations must be done by specialized personnel only, shutting of the electrical power and respecting all national installation regulations and guidelines. A.A.G. Stucchi allows the use of only A.A.G. Stucchi parts in applications where the **micro** system is installed. These parts must be installed according to the installation instructions. The company as a manufacturer is not responsible for the safety and functioning of the **micro** system if electrical or mechanical components not belonging to it are used or if there are any deviations from the installation instructions. It is then the user's responsibility to ensure the correct functionality and the electrical, electromechanical, electronic, mechanical and thermal compatibility between the **micro** system and any other third-party products that are used or even developed for the system itself (i.e. drivers/fixtures). The track, its components and also the adapters can't be used with accessories without the Quality/Approval Mark of the region. On **micro** track one can use only **micro** connections. **micro** connections can be used only with **micro** tracks. This track system is Class III and is not compatible with Class I track systems or Class III track systems from other manufacturers. Insert the appropriate power circuit protections in order to prevent short circuits or overloads.*

WARNING

- The use of NON SELV or U-OUT > 60V dc power supplies, drivers and components is strictly forbidden.

- A.A.G. Stucchi recommends the usage of an opto-insulated repeater (es. S-RP-24-48V).

If you want to create a unique Data Bus in your lighting project (building, shop, etc.), electrically connecting the low voltage track Data Bus with the Data Bus of other lighting applications, all the components involved must be SELV approved.

- It is strictly forbidden to use any kind of solvent, glue, oil, grease or cleaner in contact with MULTISYSTEM components. The company is not responsible of any damage caused by the use of the materials mentioned above.

TECHNICAL INFO

- Voltage (Input): 0 - 60 V dc

- Rated Current: max. 10A - 1A data bus

- Max functioning T: 70°C (Ta 25°C)

-  Class III (SELV)

- End-feed wiring cables: 2xAWG16 + 2xAWG22

- UL approval 48V-2A Class 2 - 1A data bus

- Maximum weight of the lighting fixture: 5N with adapter

- Tracks to be used in NON polarized versions

- Plastic components available only for NON polarized versions

- Use only NON polarized electronics

- Adapters are NOT to be inserted in bends. The only exception is adapter 9609, which may only be inserted in horizontal bends with a radius greater than 300 mm.

- ATTENTION: to limit the risk of overheating and fire, do not short-circuit the conductors

- The replacement of the 9601-I / ... cable can only be carried out by the manufacturer or his service department

Potenza fornita Power supply (W)	A Distanza alimentazione/testata (2x1,5mm ²) Distance power supply/feed unit (2x1,5mm ²)			
	5m	10m	20m	30m
	B Lunghezza binario con $\Delta v \leq 5,5\%$ (m) Track length with $\Delta v \leq 5,5\%$ (m)			
	(m)	(m)	(m)	(m)
60	50	50	50	50
100	50	50	40	25
150	50	40	20	Non ammesso Not admitted
200	40	30	Non ammesso Not admitted	Non ammesso Not admitted
250	35	20	Non ammesso Not admitted	Non ammesso Not admitted

Le indicazioni sono relative ad un carico equivalente alla potenza erogata ed equamente distribuito sulla lunghezza indicata in tabella
Information refers to a load equivalent to the power supplied and equally distributed on the relevant length in the table

alimentazione
power supply

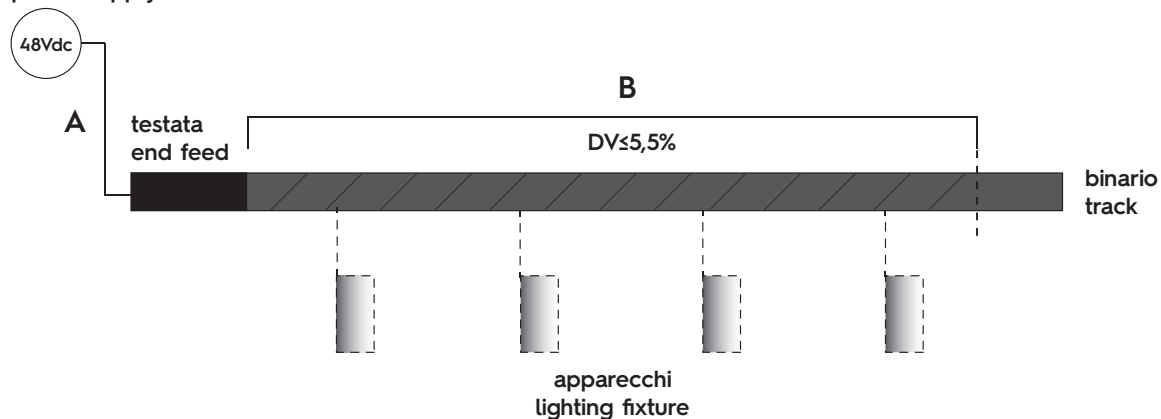

A.A.G. STUCCHI s.r.l. u.s.
Via IV Novembre 30/32, 23854
Olginate (LC) - ITALY
Ph. +39-0341-653111
Fax +39-0341-653250
info@aagstucchi.it

A.A.G. STUCCHI NORTH AMERICA, INC.
5080 North Royal Atlanta Drive
Tucker, GA 30084 - USA
Ph. +1-404-806-5399
northamerica@aagstucchi.com

A.A.G. STUCCHI ASIA PACIFIC LTD.
Regional office
Room 01, 11/fl., New Treasure Centre
N° 10 Ng Fong Street, Kowloon - HONG KONG
Ph. +852-2578-8988
Fax +852-2571-5039
hongkong@aagstucchi.hk

A.A.G. STUCCHI SHANGHAI LTD.
Rm 3007, N°738, Chang Yang Rd
YangPu area, 200082 - SHANGHAI
Ph. +86-21-51816507
Fax +86-21-51816508
east@aagstucchi.hk

EUTRAC Stromschienen GmbH
Volkmarstraße 18, D-12099 Berlin
Ph. +49 (0) 30 270009-0
Fax +49 (0) 30 270009-248
export@eutrac.de
service@eutrac.de

aagstucchi.it



eutrac.de



Aggiornamento Febbraio 2023
February 2023 update