



SERIES 3230 - SINGLE AND DOUBLE-POLE ROCKER SWITCHES

TO 10 (5) A 12 AND 24 V DC



PRODUCT FEATURES

- Attractive rocker switch (rocker separate)
- Million times proven, friction snap-action contact system
- Powerful with 100 000 switching cycles electrically and mechanically for DC voltage applications
- Indicator lamp identical
- Dust and water protected
- High variety
- With or without function illumination (LED)
- Installation from the front directly or with assembly frame
- Block connector support

ON REQUEST









- Other colors
- Other rocker symbols (laser etched)
- Other switching functions
- Other lamp variants
- With assembled rocker

Mechanical life endurance	10E4
Ambient temperature	-40 °C ... +85 °C
Material actuator housing terminals	PA glass fiber-reinforced PA silver plated
Miscellaneous	illumination with mounted rocker: day design = light gray / night design = pea green



SERIES 3230 - SINGLE AND DOUBLE-POLE ROCKER SWITCHES

TO 10 (5) A 12 AND 24 V DC

 single-pole (rocker separate)	Lighting voltage (V)	Housing color	10 (5) A 24 V DC 1E5	10 (5) A 12 V DC 1E5	Terminal type	Terminal description	Miscellaneous	Stock version
Normally open contact latching 1-step (SPST)								
3230.0102	24	■	○			3.0 x 0.8	with search lighting LED green circuit symbol: 3.01	
3230.0202	24	■	○			3.0 x 0.8	with function indicator LED red with search lighting LED green circuit symbol: 3.03	
3230.0101	12	■		○		3.0 x 0.8	with search lighting LED green circuit symbol: 3.01	
3230.0201	12	■		○		3.0 x 0.8	with function indicator LED red with search lighting LED green circuit symbol: 3.03	
Normally open contact momentary 1-step (SPNO)								
3230.0302	24	■	○			3.0 x 0.8	with search lighting LED green circuit symbol: 3.02	
3230.0301	12	■		○		3.0 x 0.8	with search lighting LED green circuit symbol: 3.02	
 double-pole (rocker separate)	Lighting voltage (V)	Housing color	10 (5) A 24 V DC 1E5	10 (5) A 12 V DC 1E5	Terminal type	Terminal description	Miscellaneous	Stock version
Changeover switch latching 1-step (DPDT)								
3230.1902	12	■	○			3.0 x 0.8	with search lighting LED green circuit symbol: 3.09	

ROCKER SWITCHES

PUSHBUTTON SWITCHES

TOGGLE SWITCHES

SLIDE SWITCHES

ROTARY SWITCHES

FOOT SWITCHES

TACT AND KEY SWITCHES

SWAP-ACTION SWITCHES

MICRO-SIGNAL SWITCHES

SENSORS







ECO





PUSH/DRIVE



SERIES 3230 - SINGLE AND DOUBLE-POLE ROCKER SWITCHES

TO 10 (5) A 12 AND 24 V DC

 Combination (rocker separate)	Lighting voltage (V)	Housing color	10 (5) A 24 V DC 1E5	10 (5) A 12 V DC 1E5	Terminal type	Terminal description	Miscellaneous	Stock version
Changeover switch latching 2-step (SPDT)								
3230.0502	24		○			3.0 x 0.8	2 x single-pole changeover switch with search lighting LED green circuit symbol: 3.31	
3230.0602	24		○			3.0 x 0.8	2 x single-pole changeover switch with function indicator LED red with search lighting LED green circuit symbol: 3.33	
3230.0501	12			○		3.0 x 0.8	2 x single-pole changeover switch with search lighting LED green circuit symbol: 3.31	
3230.0601	12			○		3.0 x 0.8	2 x single-pole changeover switch with function indicator LED red with search lighting LED green circuit symbol: 3.33	
Changeover switch momentary 2-step (SPDT momentary)								
3230.0702	24		○			3.0 x 0.8	2 x single-pole changeover switch with search lighting LED green circuit symbol: 3.32	
3230.0701	12			○		3.0 x 0.8	2 x single-pole changeover switch with search lighting LED green circuit symbol: 3.32	

 Lamp (rocker separate)	Lighting voltage (V)	Housing color	10 (5) A 24 V DC 1E5	10 (5) A 12 V DC 1E5	Terminal type	Terminal description	Miscellaneous	Stock version
Lamp								
3237.0102	24 24					3.0 x 0.8	LED red / red	
3237.0104	24 24					3.0 x 0.8	LED red / green	
3237.0106	24 24					3.0 x 0.8	LED green / green	
3237.0108	24 24					3.0 x 0.8	LED yellow / green	

ROCKER SWITCHES

PUSHBUTTON SWITCHES

TOGGLE SWITCHES

SLIDE SWITCHES

ROTARY SWITCHES

FOOT SWITCHES

TACT AND KEY SWITCHES

SNAP-ACTION SWITCHES

MICRO-SIGNAL SWITCHES

SENSORS

ECO

PUSH IN DRIVE



SERIES 3230 - SINGLE AND DOUBLE-POLE ROCKER SWITCHES

TO 10 (5) A 12 AND 24 V DC

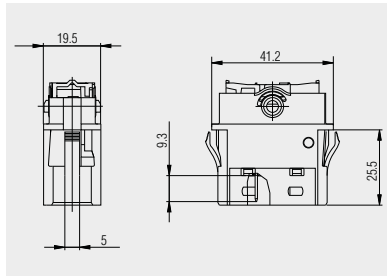

Quick-connect terminal 3.0 x 0.8

Basic types 3230 and 3237



Rocker

190.389.011 - without stop
(switching function both sides)

190.389.021 - with stop
(switching function one side)

Cap

203.442.011 - with stop both
sides (for lamp 3237)

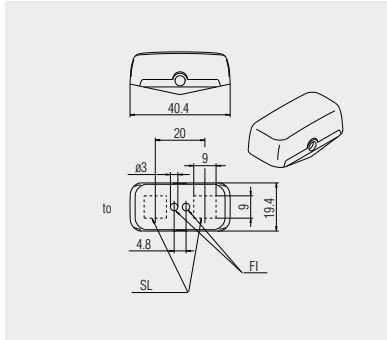

Snap-on rocker for basic type 3230 and cap for basic type 3237 (without switching function) painted black with or without stop for both or one-sided switching function. Laser etched by customer or on request.

Note:

Rocker must be ordered separately in addition to the basic switch. Assembly on customer side.

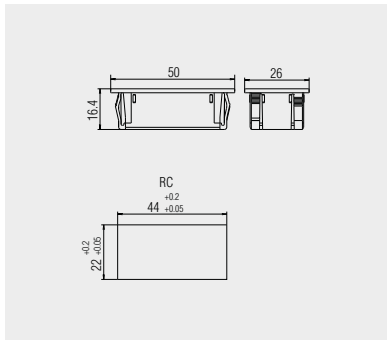

Installation frame for basic types 3230 and 3237 in black

Installation frame
217.353.021



Dummy piece for the basic types 3230 and 3237 with mounted black cap

Dummy piece
203.069.013

ROCKER SWITCHES

PUSHBUTTON SWITCHES

TOGGLE SWITCHES

SLIDE SWITCHES

ROTARY SWITCHES

FOOT SWITCHES

TACT AND KEY SWITCHES

SNAP-ACTION SWITCHES

MICRO-SIGNAL SWITCHES

SENSORS

ECO

PUSH/DRIVE



SERIES 3230 - SINGLE AND DOUBLE-POLE ROCKER SWITCHES

TO 10 (5) A 12 AND 24 V DC

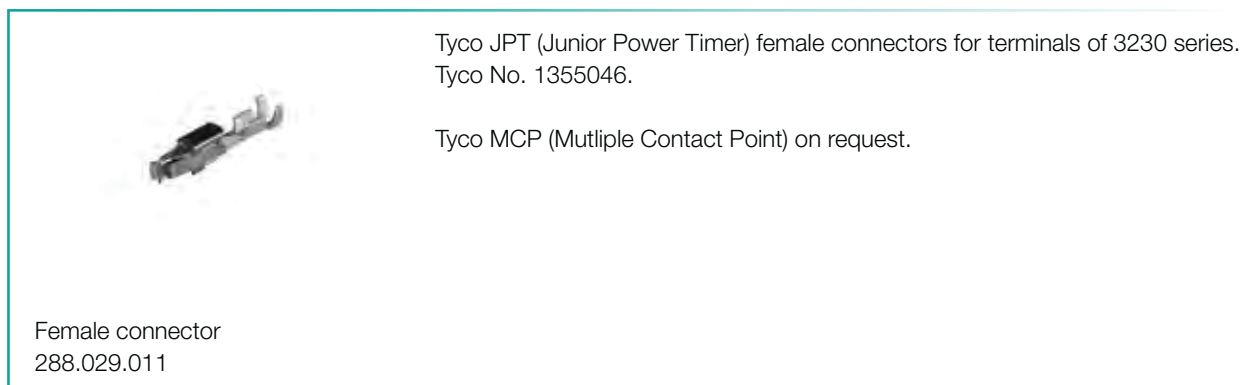
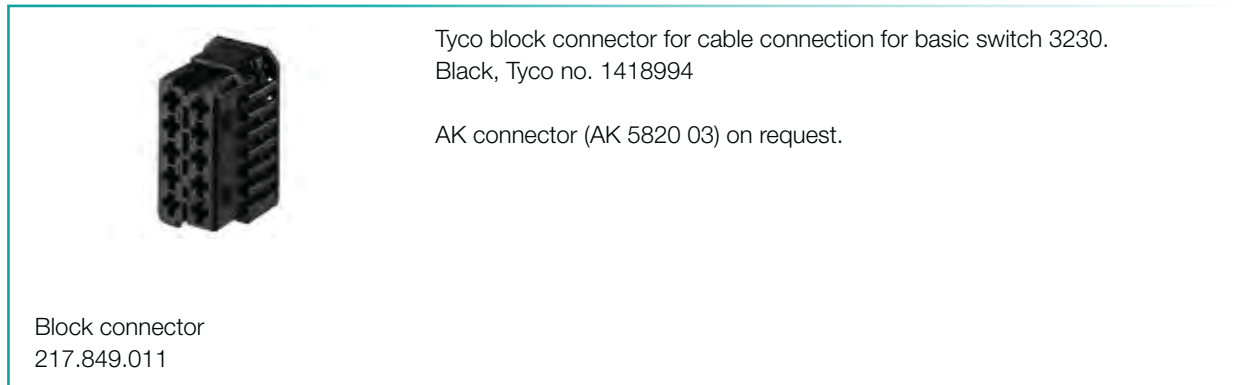
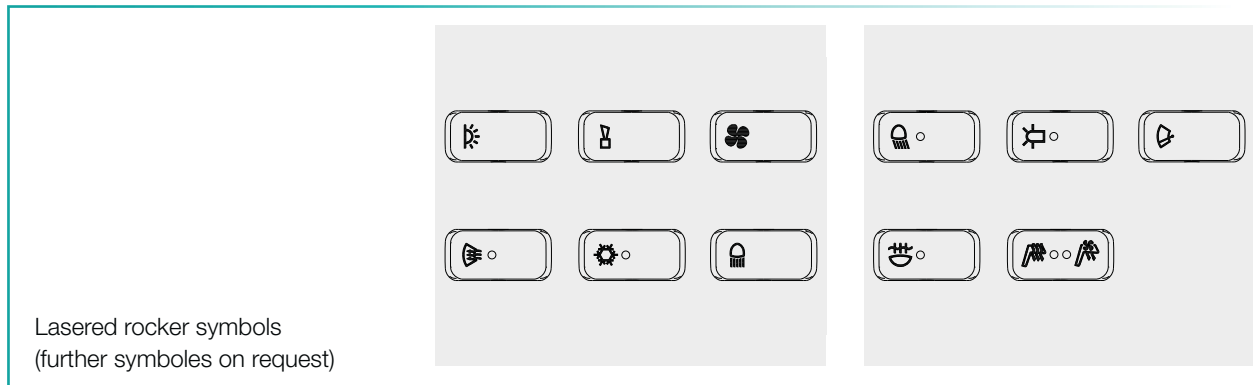

Further information under

WWW.MARQUARDT-SWITCHES.COM



SERIES 3230 - SINGLE AND DOUBLE-POLE ROCKER SWITCHES

TO 10 (5) A 12 AND 24 V DC

ROCKER SWITCHES

PUSHBUTTON SWITCHES

TOGGLE SWITCHES

SLIDE SWITCHES

ROTARY SWITCHES

FOOT SWITCHES

TACT AND KEY SWITCHES

SWAP-ACTION SWITCHES

MICRO-SIGNAL SWITCHES

SENSORS

ECO

PUSH/DRIVE

Circuit symbols

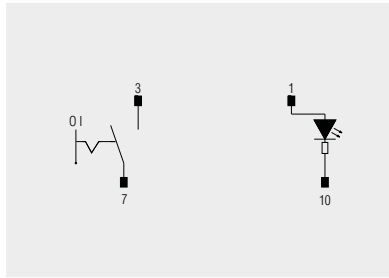

Circuit symbol: 3.01

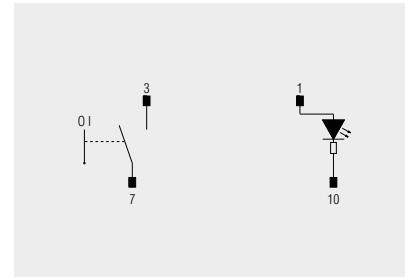

Circuit symbol: 3.02

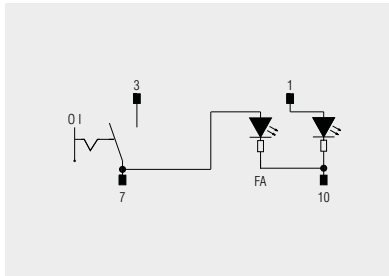

Circuit symbol: 3.03

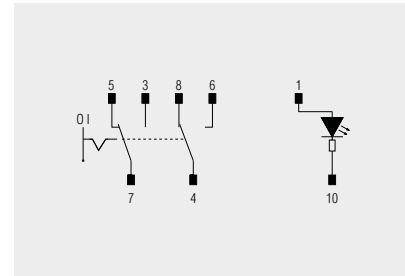

Circuit symbol: 3.09

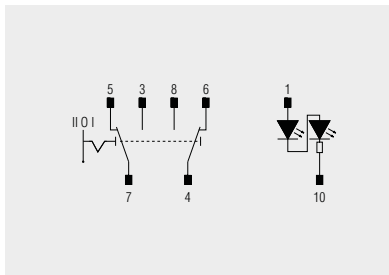

Circuit symbol: 3.31

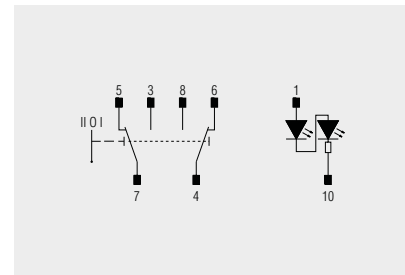

Circuit symbol: 3.32

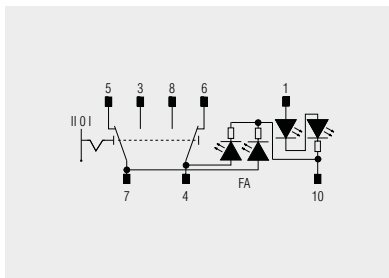

Circuit symbol: 3.33

MARQUARDT INTERNATIONAL.

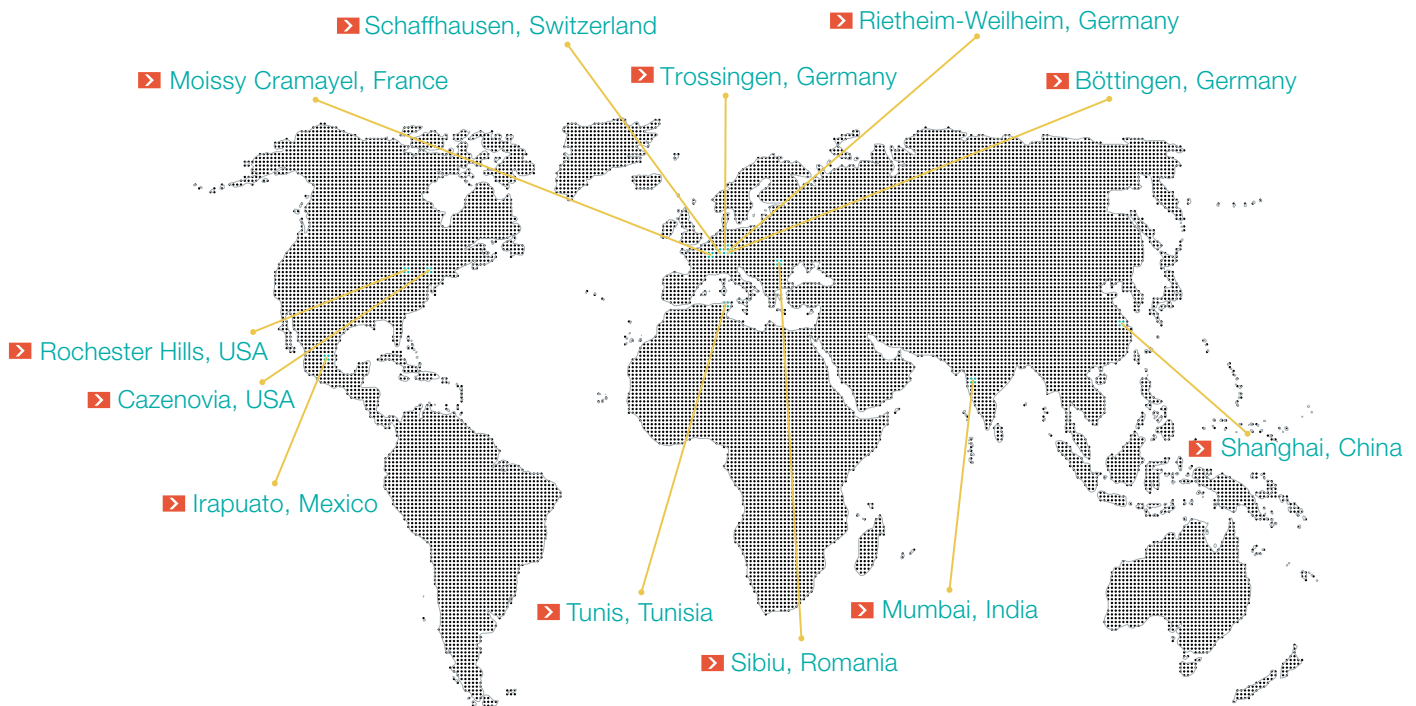

HEADQUARTERS

Marquardt Mechatronik GmbH

Schloss-Straße 16
78604 Rietheim-Weilheim / GERMANY
Tel. +49 (0)74 24/99-0
Fax +31 (0)74 24/99-2399
marquardt@marquardt.com
www.marquardt.com

Geuken



DISTRIBUTOR

GEUKEN B.V.

Wattstraat 25a
2723 RA Zoetermeer / NETHERLANDS
Tel. +31 (0)79 361 60 70
Fax +31 (0)79 361 40 90
info@geuken.nl
www.geuken.nl