

kompo

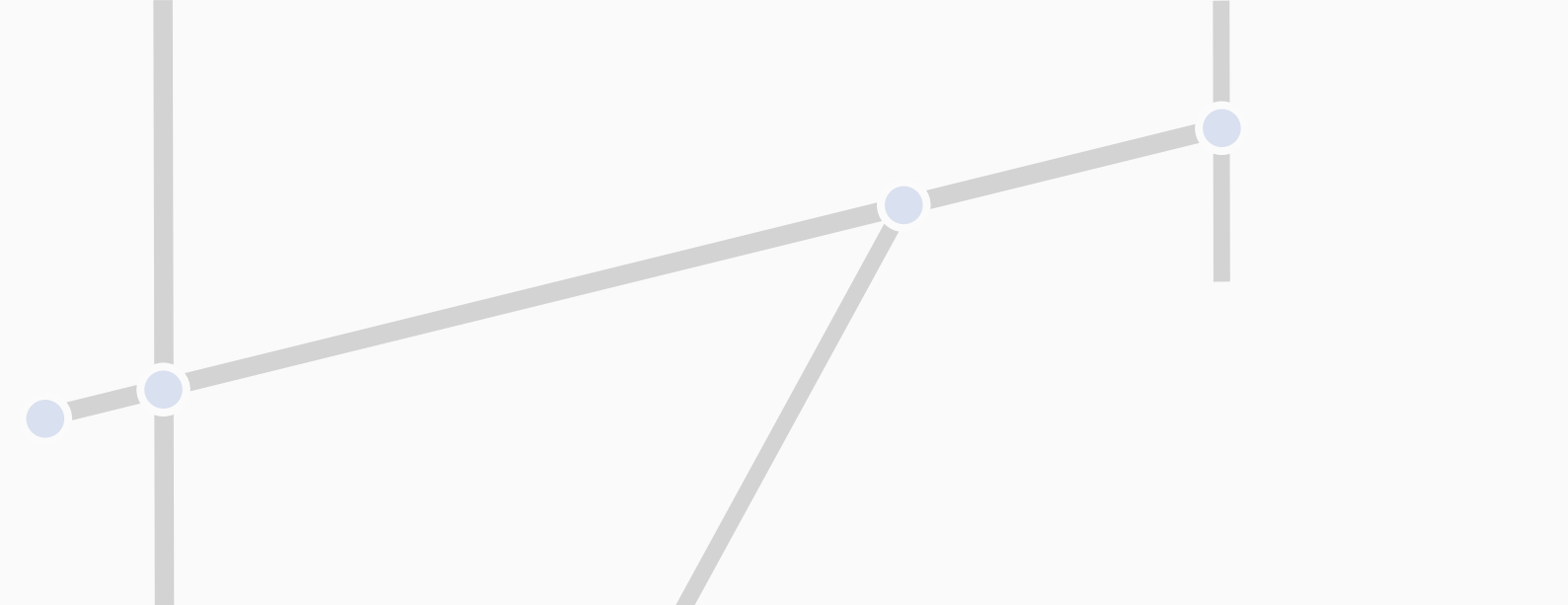

KOMPO: esempio di installazione a parete in contesto residenziale

KOMPO: installation example of wall mounted product in residential application



KOMPO: esempio di installazione a sospensione con tige in contesto residenziale

KOMPO: installation example of suspended mounted product with stem in residential application

Kompo è una struttura modulare sviluppata per creare un progetto di illuminazione dinamico e multi-livello con i binari low-voltage. Il sistema è basato su **giunti elettrificati multi-livello** che collegano facilmente i binari low-voltage (MULTISYSTEM EVO ST15-E) sia in orizzontale che in verticale che su due differenti altezze.

Questo crea **strutture tridimensionali fatte di binari**, sulle quali è possibile installare faretto, moduli di luce lineare e indiretta in base alle esigenze. Le strutture KOMPO possono essere installate a plafone o a sospensione in differenti applicazioni come retail, residential e hospitality.

Kompo is a modular structure developed to create dynamic and multi-level lighting projects with low voltage tracks.

*The system is based on **electrical multilevel connection joints** which easily link low voltage (MULTISYSTEM EVO ST15-E) tracks both horizontal and vertical and on two different high levels.*

*This creates **3D multilevel structures made of tracks**, on which it is possible to place spotlights, linear light modules and indirect light depending on the needs. KOMPO structures are suitable to be used ceiling fixed or suspended in different lighting applications, from retail to residential and hospitality.*

INFORMAZIONI TECNICHE
TECH INFO

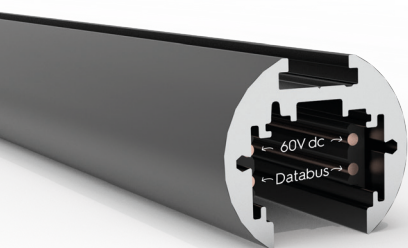

Binario EVO ST15:
EVO ST15 track:

2 circuits: 2x +/- 15A/0-60V dc
1 circuit + Data Bus: +/- 15A/0-60V + D+/D-

Materiali:

Materials:

Estruso esterno in alluminio
Colori disponibili: nero goffrato / bianco goffrato
Estruso isolante in PVC
Conduttori in rame

*External extruded body in aluminium
Available colours: black embossed / white embossed
Insulated extruded body in PVC
Copper conductors*



Materiali dei kit:

Kits material:

Corpo in alluminio
Colori disponibili: nero goffrato

Aluminium body
Available colours: black embossed



Wall/Ceiling fixing - Composition detail

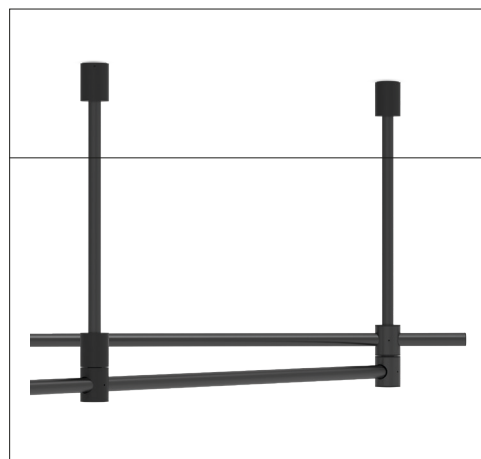

Suspended fixing - Composition detail
Stem Length 200 mm - 500 mm



- 1 - SENZAFINE TWIST T30
- 2 - SENZAFINE TWIST CROSS T30C
- 3 - SENZAFINE FLAT M16 OPAL
- 4 - SENZAFINE FLAT M16 UGR
- 5 - SENZAFINE FLAT M16 LENS



Esempio di composizione a parete / Wall composition example

DISTINTA BASE
BILL OF MATERIALS

QUANTITÀ
QUANTITY

1	- KOMPO K-15E/C2-B	x 2
2	- KOMPO K-15E/C6-B	x 2
3	- Binario EVO ST15-E / Track EVO ST15-E	x 3
4	- SENZAFINE M16 FLAT OPAL	x 2
5	- Adattatore / Adapter 9519-166-M..	x 2
6	- Tappo / End cap	x 6

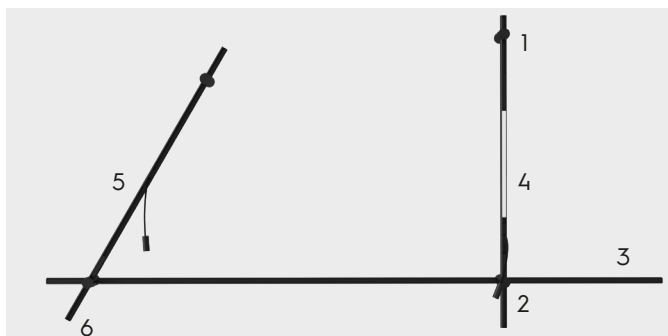

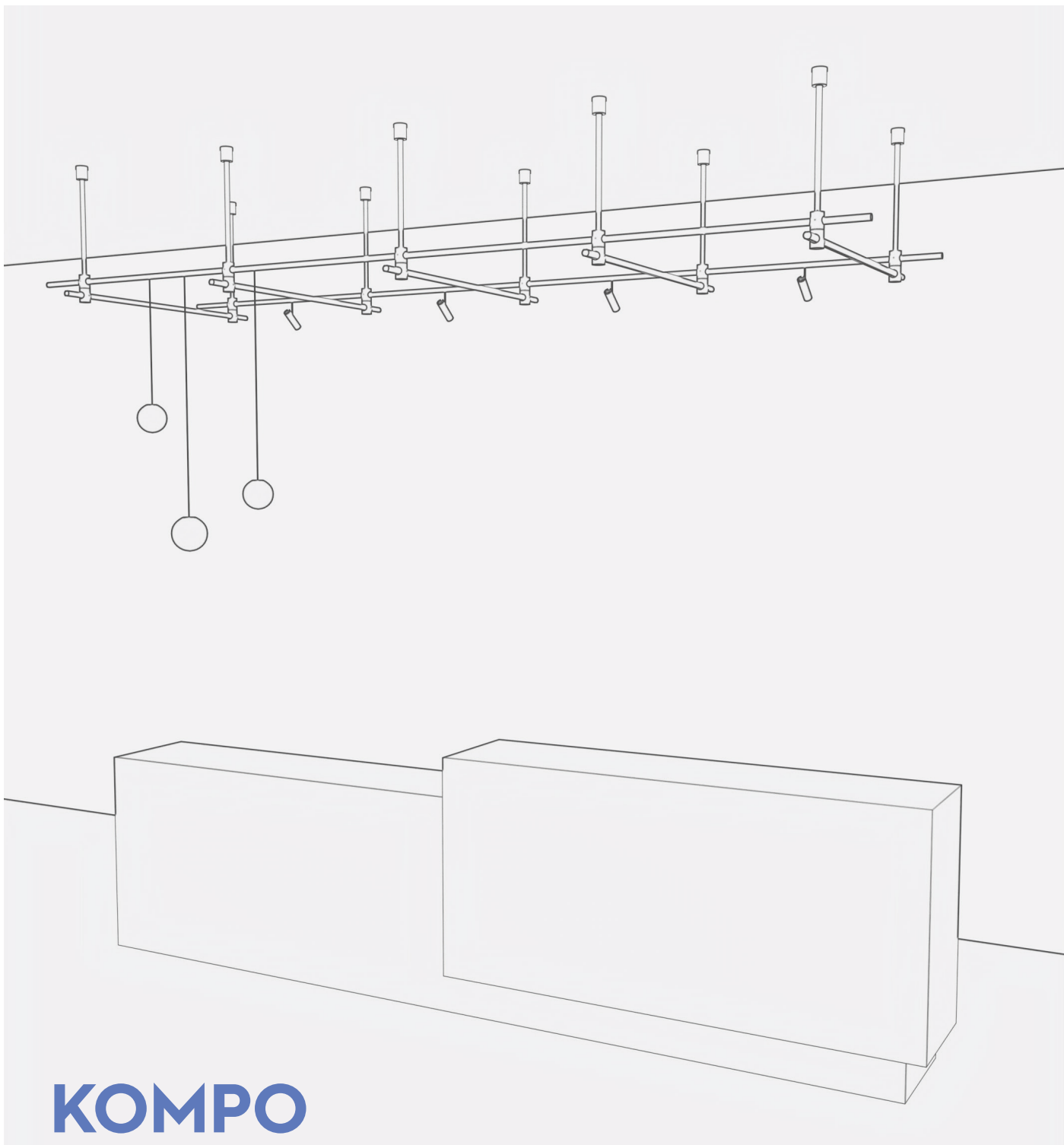

Esempio di composizione a sospensione / *Suspension composition example*

DISTINTA BASE <i>BILL OF MATERIALS</i>	QUANTITÀ <i>QUANTITY</i>
1 - KOMPO K-15E/C18-B	x 10
2 - Binario EVO ST15-E / <i>Track EVO ST15-E</i>	x 7
3 - SENZAFINE M16 FLAT UGR	x 2
4 - Adattatore / <i>Adapter 9519-166-M...</i>	x 4
5 - Tappo / <i>End cap</i>	x 14

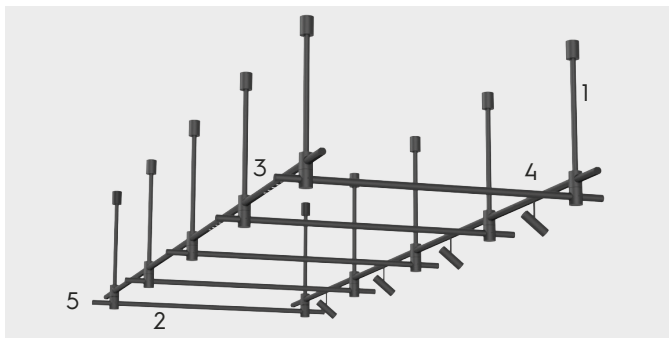



Esempio di composizione a plafone / Ceiling composition example

DISTINTA BASE
BILL OF MATERIALS

QUANTITÀ
QUANTITY

1	- KOMPO K-15E/C24-B	x 2
2	- KOMPO K-15E/C6-B	x 4
3	- Binario EVO ST15-E / Track EVO ST15-E	x 5
4	- SENZAFINE TWIST T30	x 3
5	- SENZAFINE TWIST CROSS T30C	x 2
6	- Tappo / End cap	x 10

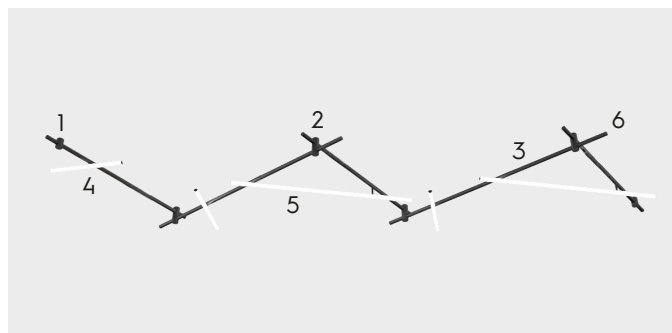

BINARIO ROUND
ROUND TRACK

Colori disponibili: **B** nero gofrato RAL 9005 **W2** bianco gofrato RAL 9016
Available colours: **black embossed** **white embossed**

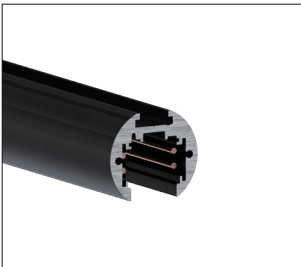

9500-.../B-ST15-E
9500-.../W2-ST15-E

Non compatibile con moduli di luce SENZAFINE M22/M22A
Not suitable for use with SENZAFINE M22/M22A light modules

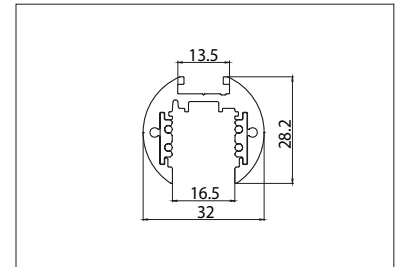

ACCESSORI
ACCESSORIES

Colori disponibili: **B** nero gofrato RAL 9005 **W2** bianco gofrato RAL 9016
Available colours: **black embossed** **white embossed**



9504/ST15-P-...

Tappo di chiusura in plastica
Plastic end cap

W2 **B** Effetto gofrato
Embossed effect

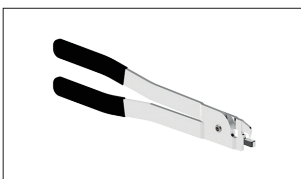

S-9000/T

Tronchese per taglio conduttori del binario
Cutting tool for track conductors

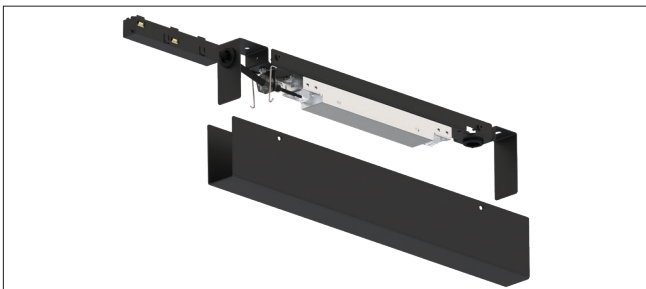

9500/P-100E-...-CI-N

- Composto da:
- staffa per fissaggio a soffitto
 - alimentatore 230Vac/48Vdc SELV
 - testata di alimentazione
 - cavo di alimentazione testata (20mm)
 - rosone metallico
- Includes:
- ceiling bracket
 - driver 230Vac/48Vdc SELV
 - end-feed
 - end-feed power wire (20mm)
 - metallic cup

W2 **B** Gofrato
Embossed

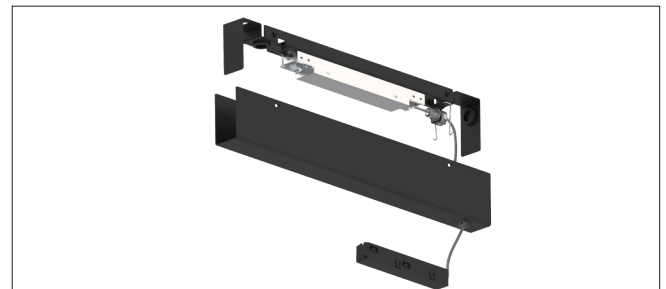

9500/P-100E-...-SP-N

- 230Vac/48Vdc SELV
- Composto da:
- staffa per fissaggio a soffitto
 - alimentatore 230Vac/48Vdc SELV
 - testata di alimentazione
 - cavo di alimentazione testata (2000mm)
 - rosone metallico
- Includes:
- ceiling bracket
 - driver 230Vac/48Vdc SELV
 - end-feed
 - end-feed power wire (2000mm)
 - metallic cup

W2 **B** Gofrato
Embossed

KIT A PLAFONE
CEILING KITS

Binario Singolo - Single track



K-15E/C1-B

Distanziale + Snodo chiuso
Spacer + End junction

B



K-15E/C23-B

Snodo chiuso
End junction

B



K-15E/C2-B

Distanziale + Snodo passante
Spacer + Pass through junction

B

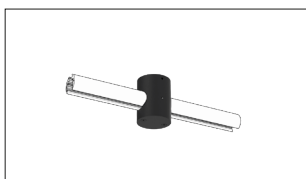

K-15E/C24-B

Snodo passante
Pass through junction

B

Binario Doppio - Double track

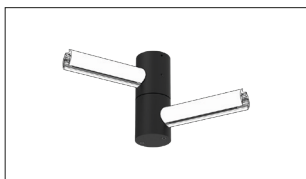

K-15E/C3-B

Doppio snodo chiuso
Double end junction

B



K-15E/C4-B

Snodo chiuso + Snodo passante
End junction + Pass through junction

B

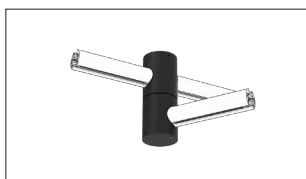

K-15E/C5-B

Snodo passante + Snodo chiuso
Pass through junction + End junction

B

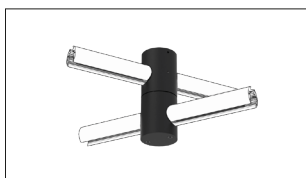

K-15E/C6-B

Doppio snodo passante
Double pass through junction

B

KIT A SOSPENSIONE CON TIGE
SUSPENSION KITS WITH STEM

Binario Singolo - Single track



K-15E/C7-B

Rosone + Tige 200mm + Snodo chiuso
Cup + Stem (200 mm) + End junction

B



K-15E/C8-B

Rosone + Tige 200mm + Snodo passante
Cup + Stem (200 mm) + Pass through junction

B

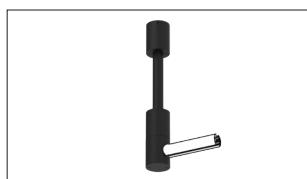

K-15E/C27-B

Rosone + Tige 200mm + Distanziale + Snodo chiuso
Cup + Stem (200 mm) + Spacer + End junction

B

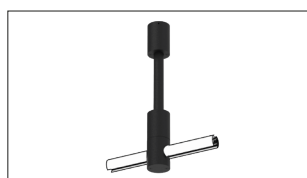

K-15E/C28-B

Rosone + Tige 200mm + Distanziale + Snodo passante
Cup + Stem (200 mm) + Spacer + Pass through junction

B

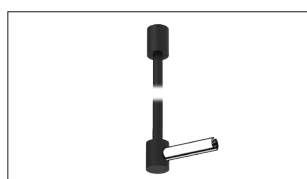

K-15E/C13-B

Rosone + Tige 500mm + Snodo chiuso
Cup + Stem (500 mm) + End junction

B



K-15E/C14-B

Rosone + Tige 500mm + Snodo passante
Cup + Stem (500 mm) + Pass through junction

B



K-15E/C29-B

Rosone + Tige 500mm + Distanziale + Snodo chiuso
Cup + Stem (500 mm) + Spacer + End junction

B

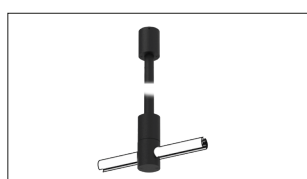

K-15E/C30-B

Rosone + Tige 500mm + Distanziale + Snodo passante
Cup + Stem (500 mm) + Spacer + Pass through junction

B

Binario Doppio - Double track

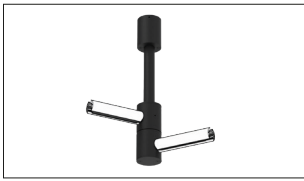

K-15E/C9-B

Rosone + Tige 200mm + Doppio snodo chiuso
Cup + Stem (200 mm) + Double end junction

B

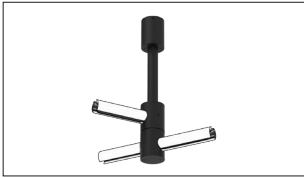

K-15E/C10-B

Rosone + Tige 200mm + Snodo chiuso + Snodo passante
Cup + Stem (200 mm) + End junction + Pass through junction

B

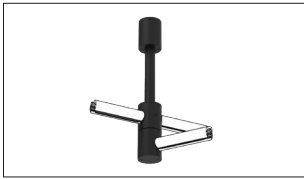

K-15E/C11-B

Rosone + Tige 200mm + Snodo passante + Snodo chiuso
Cup + Stem (200 mm) + Pass through junction + End junction

B

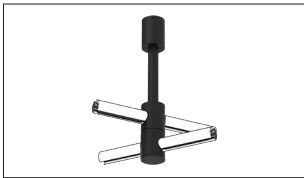

K-15E/C12-B

Rosone + Tige 200mm + Doppio snodo passante
Cup + Stem (200 mm) + Double Pass through junction

B

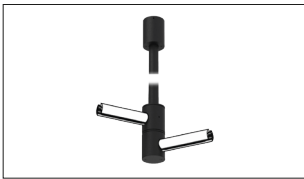

K-15E/C15-B

Rosone + Tige 500mm + Doppio snodo chiuso
Cup + Stem (500 mm) + Double end junction

B



K-15E/C16-B

Rosone + Tige 500mm + Snodo chiuso + Snodo passante
Cup + Stem (500 mm) + End junction + Pass through junction

B



K-15E/C17-B

Rosone + Tige 500mm + Snodo passante + Snodo chiuso
Cup + Stem (500 mm) + Pass through junction + End junction

B

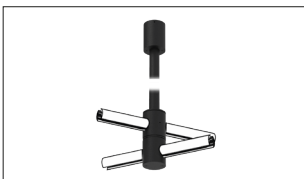

K-15E/C18-B

Rosone + Tige 500mm + Doppio Snodo passante
Cup + Stem (500 mm) + Double Pass through junction

B

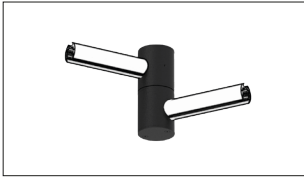

K-15E/C19-B

Doppio snodo chiuso
Double end junction

B



K-15E/C20-B

Snodo chiuso + Snodo passante
End junction + Pass through junction

B

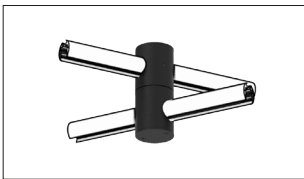

K-15E/C22-B

Doppio snodo passante
Double pass through junction

B

Il distributore ha l'obbligo di informare l'utente sulle modalità di utilizzo di tutti i componenti forniti.

Materiali, disegni, programma di fabbricazione e confezioni possono subire modifiche o variazioni senza obbligo di preavviso.

Si declina ogni responsabilità per eventuali errori di stampa.

Tutte le operazioni descritte in questo foglio di istruzioni devono essere eseguite da personale specializzato, escludendo tensione dall'impianto e rispettando le norme nazionali di installazione. A.A.G. Stucchi permette solo l'utilizzo dei componenti A.A.G. Stucchi all'interno delle applicazioni che utilizzano il sistema MULTISYSTEM® EVO. Questi componenti devono essere installati secondo le istruzioni di montaggio fornite dall'azienda. L'azienda, come produttrice, non è responsabile della sicurezza e del funzionamento del sistema in caso si utilizzino componenti non appartenenti ad esso o se le istruzioni di montaggio non venissero rispettate. È inoltre responsabilità dell'utente garantire la compatibilità elettrica, meccanica e termica del sistema rispetto alle strutture sulle quali viene ancorato e tra il sistema MULTISYSTEM® EVO e gli apparecchi di illuminazione utilizzati. Il binario ed i suoi componenti, compresi gli adattatori, non sono intercambiabili con accessori che non riportino il Marchio di qualità. Sul binario MULTISYSTEM® EVO è possibile utilizzare solo le connessioni MULTISYSTEM® EVO. Le connessioni MULTISYSTEM® EVO possono essere utilizzate solo su binari MULTISYSTEM® EVO. Durante il montaggio dei binari rispettare le distanze di ancoraggio e non superare i carichi indicati nella relativa sezione.

AVVERTENZE

- È vietato utilizzare alimentatori, driver, sistemi Bus Dati e componenti non omologati SELV e/o che abbiano una U-OUT maggiore di 60 V dc
- A.A.G. Stucchi raccomanda l'utilizzo di un ripetitore optoisolato Bus Data compatibile (es. S-RP-24-48V)
- I 4 conduttori del binario possono essere utilizzati in due modi differenti:
 - Per avere due alimentazioni separate (2 circuiti a 0 - 60 V dc)
 - Per avere un circuito per l'alimentazione a 60 V dc ed un circuito per il Bus Dati

In caso fosse necessario all'interno della stessa installazione (edificio, negozio etc) creare un unico Bus Data unendo elettricamente il Bus Dati del binario a bassa tensione con quello di altri apparecchi di illuminazione è necessario che tutti i componenti utilizzati siano classificati SELV.

È severamente vietato utilizzare qualsiasi tipo di solvente, colla, olio, sgrassatore o detergente a contatto con tutti i componenti del sistema MULTISYSTEM® EVO. L'azienda non è responsabile di eventuali danni causati dall'utilizzo di suddetti materiali.

INFORMAZIONI TECNICHE

- Tensione (in entrata): 0 - 60 V dc
- Corrente: max. 15A
- T massima di funzionamento: 70°C
-  Classe III (SELV)
- Certificazione UL 48V-12A.
- Peso massimo dell'apparecchio di illuminazione: 10N con adattatore standard; 20N con adattatore meccanico
- Binari per utilizzo sia in versione NON polarizzata che polarizzata
- Componenti plastici disponibili nelle versioni NON polarizzata e polarizzata

The distributor is obliged to provide its customers with guidance on the correct use of all components supplied.

Materials, designs, our development program and packages may be subjected to changes without notice.

We decline all responsibility for any misprint.

All the described operations of this instructions page must be done by specialized personnel only. Exclude voltage plant. Please respect national installation regulations. The manufacturer allows to use only MULTISYSTEM® EVO parts in applications where its track system is used.

These parts must be installed according to the installation instructions. The company as a manufacturer is not responsible for the safety and functioning of the MULTISYSTEM® EVO system if parts not belonging to it are used or if any deviation from the installation instructions occurs.

It is then the user's responsibility to ensure the electrical, mechanical and thermal compatibility between MULTISYSTEM® EVO and the structure where it is installed and the fixtures used with it. MULTISYSTEM® EVO tracks, its components and also the adapters can't be used with accessories without the Quality Mark. On MULTISYSTEM® EVO tracks one can use only MULTISYSTEM® EVO connections. MULTISYSTEM® EVO connections can be used only with MULTISYSTEM® EVO tracks. Do not exceed listed loading indicated in the relevant section and respect fixing distances during the track mounting.

WARNING

- The use of NON SELV or U-OUT > 60V dc power supplies, drivers and components is strictly forbidden.
- A.A.G. Stucchi recommends the usage of an opto-insulated repeater Bus Data compatible (es. S-RP-24-48V).
- You can choose to use the 4 conductors of the track in 2 different modes:
 - 2 different power supplies (2 circuits, 0 - 60V dc)
 - 1 circuit for 60V dc and 1 circuit for Data Bus

If you want to create a unique Data Bus in your lighting project (building, shop, etc.), electrically connecting the low voltage track Data Bus with the Data Bus of other lighting applications, all the components involved must be SELV approved.

It is strictly forbidden to use any kind of solvent, glue, oil, grease or cleaner in contact with MULTISYSTEM® EVO components. The company is not responsible of any damage caused by the use of the materials mentioned above.

TECHNICAL INFO

- Voltage (Input): 0 - 60 V dc
- Rated Current: max. 15A
- Max functioning T: 70°C
-  Class III (SELV)
- UL approval 48V-12A
- Maximum weight of the lighting fixture: 10N with standard adapter; 20N with mechanical adapter
- Tracks to be used both in NON polarized and polarized versions
- Plastic components available for NON polarized and polarized versions

Potenza fornita Power supply (W)	A Distanza alimentazione/testata (2x1,5mm ²) Distance power supply/feed unit (2x1,5mm ²)			
	5m	10m	20m	30m
	B Lunghezza binario con $\Delta v \leq 5,5\%$ (m) Track length with $\Delta v \leq 5,5\%$ (m)			
	(m)	(m)	(m)	(m)
60	50	50	50	50
100	50	50	40	25
150	50	40	20	Non ammesso Not admitted
200	40	30	Non ammesso Not admitted	Non ammesso Not admitted
250	35	20	Non ammesso Not admitted	Non ammesso Not admitted

Le indicazioni sono relative ad un carico equivalente alla potenza erogata ed equamente distribuito sulla lunghezza indicata in tabella
Information refers to a load equivalent to the power supplied and equally distributed on the relevant length in the table

alimentazione
power supply

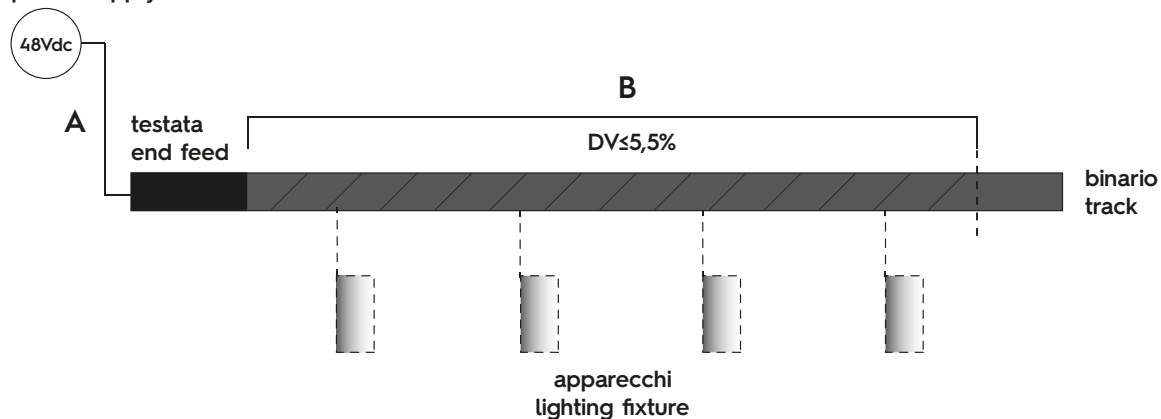

A.A.G. STUCCHI s.r.l. u.s.
Via IV Novembre 30/32, 23854
Olginate (LC) - ITALY
Ph. +39-0341-653111
Fax +39-0341-653250
info@aagstucchi.it

A.A.G. STUCCHI NORTH AMERICA, INC.
5080 North Royal Atlanta Drive
Tucker, GA 30084 - USA
Ph. +1-404-806-5399
northamerica@aagstucchi.com

A.A.G. STUCCHI ASIA PACIFIC LTD.
Regional office
Room 01, 11/fl., New Treasure Centre
N° 10 Ng Fong Street, Kowloon - HONG KONG
Ph. +852-2578-8988
Fax +852-2571-5039
hongkong@aagstucchi.hk

A.A.G. STUCCHI SHANGHAI LTD.
Rm 3007, N°738, Chang Yang Rd
YangPu area, 200082 - SHANGHAI
Ph. +86-21-51816507
Fax +86-21-51816508
east@aagstucchi.hk

EUTRAC Stromschienen GmbH
Volkmarstraße 18, D-12099 Berlin
Ph. +49 (0) 30 270009-0
Fax +49 (0) 30 270009-248
export@eutrac.de
service@eutrac.de

aagstucchi.it



eutrac.de



Aggiornamento Aprile 2023

April 2023 update