



ONETRACK



Arclightstudio

Esempi di applicazione della gamma ONETRACK® e H32 Down in contesto retail.
Retail application example of ONETRACK® and H32 Down.



Arclightstudio

Esempi di applicazione della gamma ONETRACK® in contesto Hospitality.
Hospitality application example of ONETRACK® range.



A.A.G. Stucchi presenta **ONETRACK™ ADVANCE**
l'evoluzione della gamma ONETRACK™ verso la **SOSTENIBILITÀ**

*A.A.G. Stucchi presents **ONETRACK™ ADVANCE**
the evolution of ONETRACK™ range towards **SUSTAINABILITY***

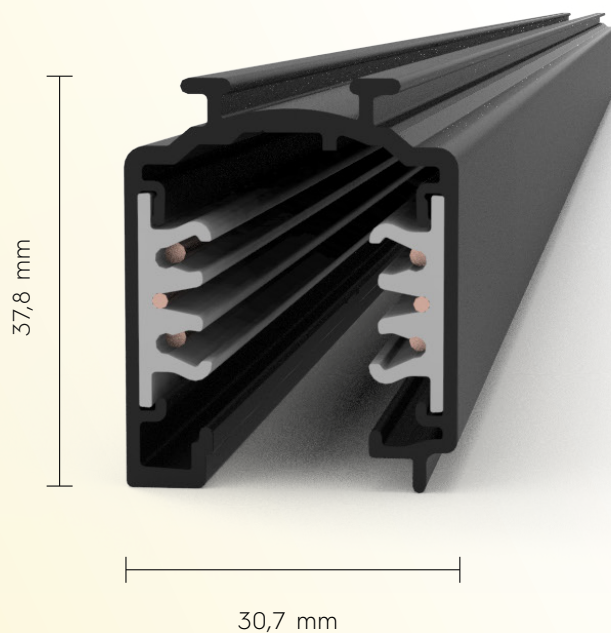



ONETRACK™ ADVANCE mantiene inalterati i concetti alla base del posizionamento della gamma ONETRACK™ evolvendo nella sua nuova versione che ne aumenta il valore aggiunto.

ONETRACK™ ADVANCE keeps the peculiar and successful features of ONETRACK™ range, evolving into its new version increasing its added value.

GREEN

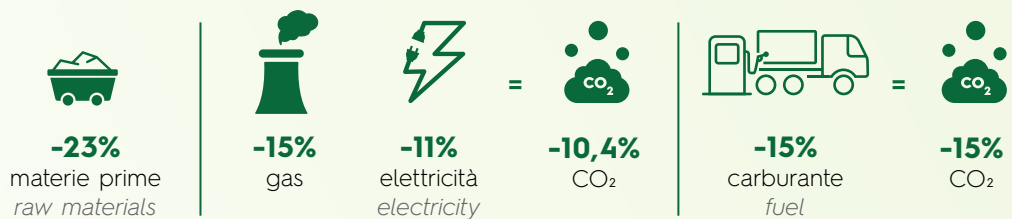

EFFICIENT



Ottimizza i processi di produzione, i costi e i livelli di stock poiché utilizza gli stessi adattatori, connessioni ed accessori della gamma ONETRACK™.

Optimizes production process, costs and stock levels as it uses same adapters, connections and accessories of ONETRACK™ range.

RESPONSIBLE



Risposta pro-attiva alle necessità del mercato, della società e dell'ambiente.

Pro-active response to the current market, society and environment's needs.

EASY



Permette di modificare solo i codici del binario a catalogo, favorendo lo switch.

Need to change only the track codes in your communication to make the switch easier.

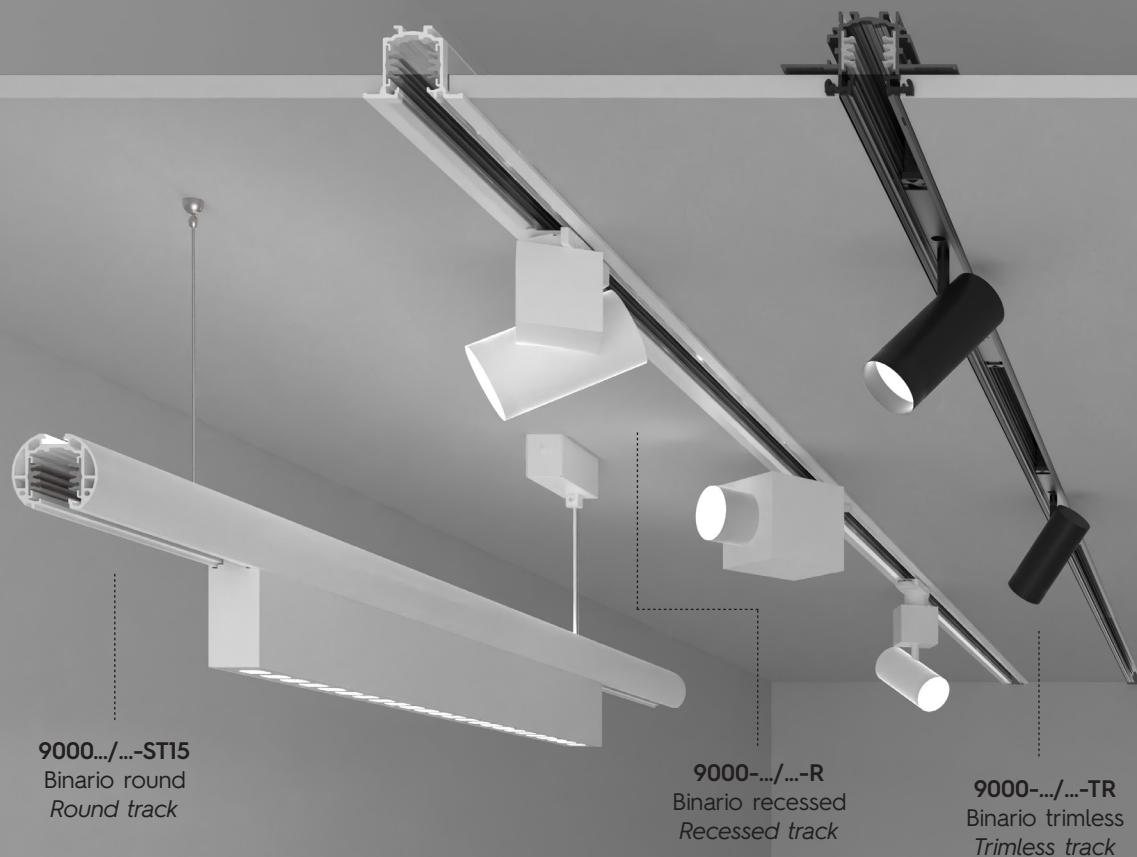

9000.../...-ST15
Binario round
Round track

9000-.../...-R
Binario recessed
Recessed track

9000-.../...-TR
Binario trimless
Trimless track

CODICI PRODOTTO
PRODUCT CODES

| | | | | |
|-------|--|---|---|---|
| 9000A | | W (bianco/white) | - | ST (a superficie/sospeso) (surface/suspended track) |
| 9000 | | G (anodizzato/anodized) B (nero/black) | - | R (da controsoffitto/recessed) H (doppia emissione/double emission) ST15 (round) TR (trimless) |
| | | W (bianco/white) B (nero/black) | - | |

230V (3 fasi + DALI)

ONETRACK® è il sistema completo per illuminazione a binari A.A.G. Stucchi che rappresenta non solo lo **stato dell'arte** per i progetti che prevedono da subito l'utilizzo di sistemi di illuminazione controllabile, ma anche la scelta più lungimirante per sistemi a luce non controllabile, perchè ne garantisce la possibilità di **upgrade** in fasi successive. Un prodotto concettualmente all'avanguardia ed adatto ad essere utilizzato in sistemi di luce Human Centric Lighting, che rappresentano il futuro dell'illuminazione. Il sistema ONETRACKR è una **piattaforma universale** che si adatta a ogni necessita presente e futura, portando notevoli **vantaggi pratici e immediati** come la riduzione dei 2/3 dei codici prodotto e, di conseguenza, un drastico calo dei livelli di stock. Una gamma completa di binari, connessioni, adattatori ed accessori che possono essere personalizzati con il proprio logo. E possibile inoltre richiedere la personalizzazione del confezionamento e dei fogli illustrativi. I binari ONETRACKR sono disponibili in varie lunghezze (1,2,3,4,m) e colori (bianco, nero, grigio).



9000A-.../...-ST
Binario a sospensione
Suspended track

9000-.../...-H
Binario biemissione
uso rovesciato
Double emission track
reverse use

9000-.../...-H
Binario biemissione
uso standard
Double emission track
standard use

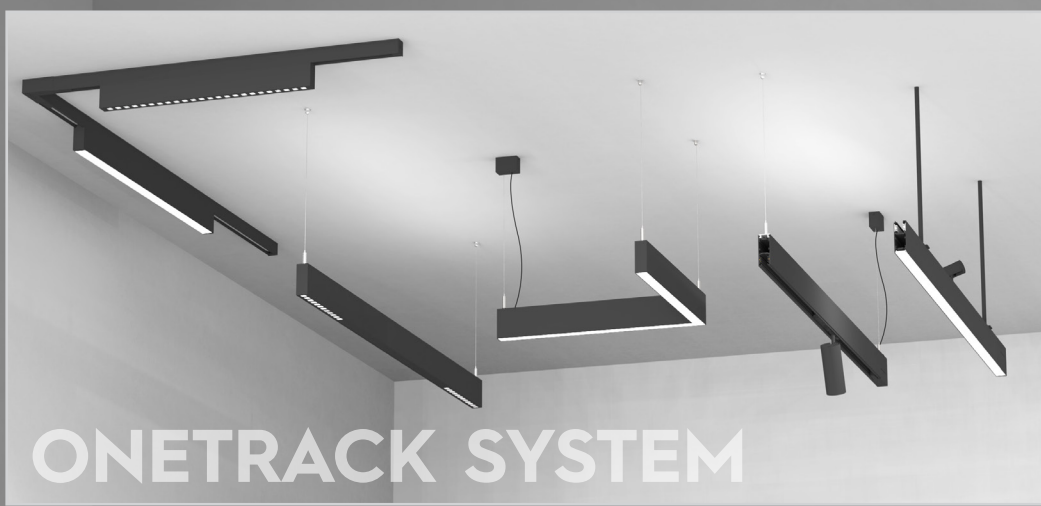

230V (3 phase + DALI)

ONETRACK® is the track lighting complete system by A.A.G. Stucchi. This new **state-of-the-art** platform is for use in lighting projects employing controllable and fixed output systems. As the platform makes **upgrading** possible at any moment, non-controllable installations are future proof. The system flexible communication lines ensure its use in Human Centric Lighting systems, the future for the lighting field. ONETRACK® is a **universal platform** that fits any current or future need and brings several **practical and immediate advantages**. Due to its flexibility ONETRACK® system allows lighting manufacturers to offer all the current systems with 1/3 of the product codes, drastically reducing the inventory levels. The complete range of tracks, connections adapters and accessories can be customized with a brand logo. It is also possible to customize the packaging and the instruction sheets. ONETRACK® tracks are available in different lengths (1,2,3,4m) and colours (white, black, grey).

COME SCEGLIERE IL TUO BINARIO

HOW TO CHOOSE THE TRACK YOU NEED

PROFILI

PROFILES

Colori disponibili:
Available colours:

- B** nero black RAL 9005
- G** grigio grey Anodizzato Anodized
- W** bianco white RAL 9010

BINARI A SUPERFICIE/SOSPESI / SURFACE/SUSPENDED TRACKS

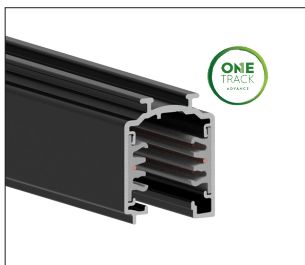

9000A-.../B-ST
9000A-.../G-ST
9000A-.../W-ST

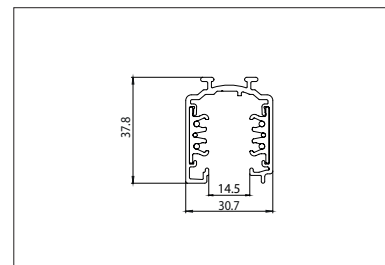

BINARIO ROUND / ROUND TRACK

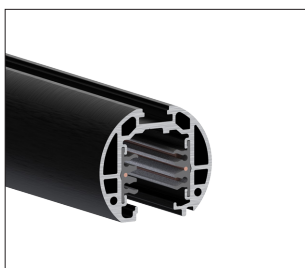

9000-.../B-ST15
9000-.../W-ST15

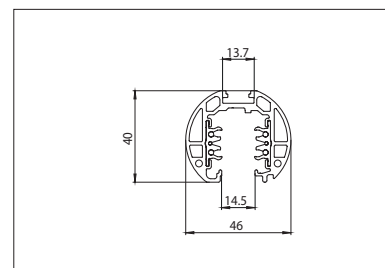

BINARIO AD INCASSO / RECESSED TRACK

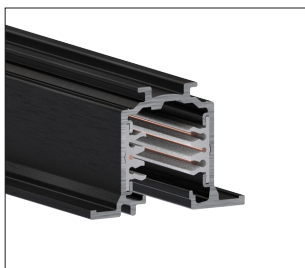

9000-.../B-R
9000-.../W-R

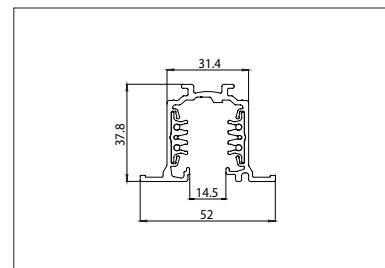

BINARIO TRIMLESS / TRIMLESS TRACK



9000-.../B-TR
9000-.../W-TR

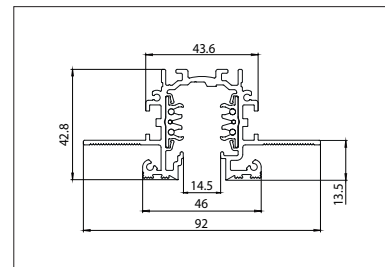

BINARIO DOPPIA EMISSIONE / DOUBLE EMISSION TRACK



9000-.../B-H
9000-.../W-H

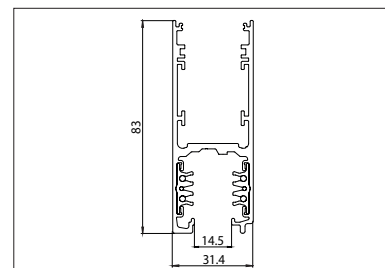

ACCESSORI PER BINARIO

TRACK ACCESSORIES

Per binario:
For track:

ST

a superficie/sospeso
surface/suspended

ST15

round

Colori disponibili:
Available colours:

B

nero
black

G

grigio
grey

W

bianco
white



grezzo
raw

R

recessed

TR

trimless

H

doppia emissione
double emission



9004/...

Tappo di chiusura con vite di blocco
End cap with locking screw

W **G** **B**

ST

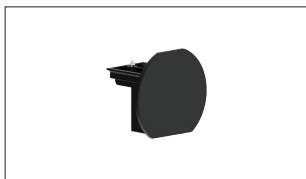

9004-ST15/...

Tappo di chiusura con vite di blocco
End cap with locking screw

W **B**

ST15



9004-R/...

Tappo di chiusura con vite di blocco
End cap with locking screw

W **G** **B**

R

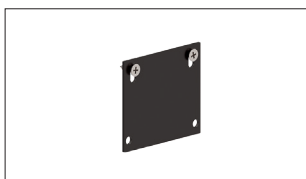

9004/TR-B

Tappo di chiusura con vite di blocco per lato senza testata
End cap with locking screw for side with no end-feed

W **B**

TR



9004/TRL-B

Tappo di chiusura con vite di blocco per lato senza testata e copertura testata trimless
End cap with locking screw for side with no end-feed and trimless end-feed cover

W **B**

TR



9004/...-H

Tappo di chiusura con vite di blocco
End cap with locking screw

W **B**

H



S-9000/H-...

Gancio di sospensione
Suspension hook

W **G** **B**

ST

R

ST15

H

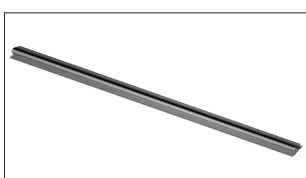

S-9000/GP-...

Guaina di protezione supplementare
Additional cover strip for track

W **G** **B**

ST

R

ST15

H

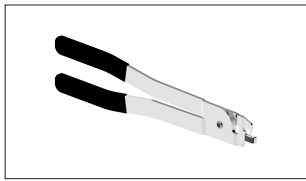

S-9000/T

Tronchese per taglio conduttori del binario
Cutting tool for track conductors

ST R
ST5 H

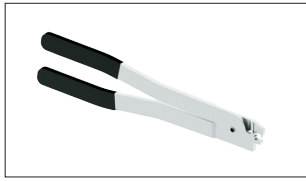

S-9000/T-TR

Tronchese per taglio conduttori del binario
Cutting tool for track conductors

TR



S-9000/TP-G

Tappo di protezione supplementare per asole binario
Additional closure cap for track slots

G

ST
R



S-9000/H-C1-OP-2000

Schermo opalino $T_L=70\%$ (L=2000mm)
Opal screen $T_L=70\%$ (L=2000mm)

H



S-9000/H-C2-OP-2000

Schermo opalino $T_L=76\%$ (L=2000mm)
Opal screen $T_L=76\%$ (L=2000mm)

H

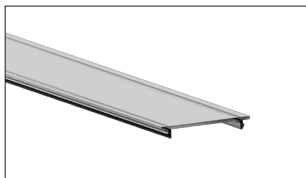

S-9000/H-C3-OP-2000

Schermo opalino (L=2000mm)
Opal screen (L=2000mm)

H

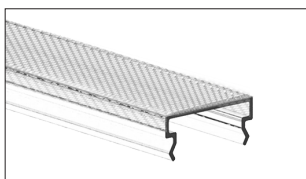

S-9300/MIC-2000

Schermo microprismatico $T_L=87\%$ (L=2000mm)
Microprismatic screen $T_L=87\%$ (L=2000mm)

H

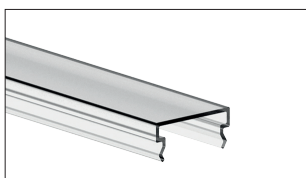

S-9300/OP-2000

Schermo opalino $T_L=85\%$ (L=2000mm)
Opal screen $T_L=85\%$ (L=2000mm)

H

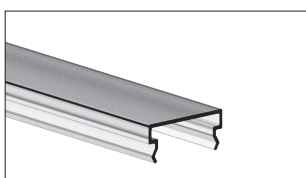

S-9300/OPN-2000

Schermo opalino $T_L=56\%$ (L=2000mm)
Opal screen $T_L=56\%$ (L=2000mm)

H

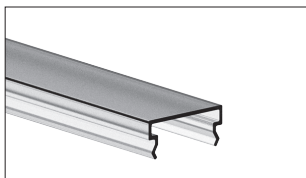

S-9300/OPS-3000

Schermo opalino $T_L=74\%$ (L=3000mm)
Opal screen $T_L=74\%$ (L=3000mm)

H

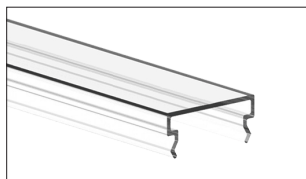

S-9300/TR-2000

Schermo trasparente $T_L=90\%$ (L=2000mm)
Transparent screen $T_L=90\%$ (L=2000mm)

H

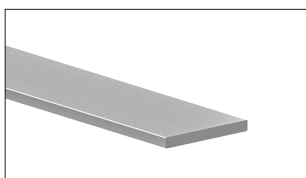

S-5033/2000

Supporto LED in alluminio (L=2000mm)
Aluminium LED support (L=2000mm)

H

ACCESSORI PER IL FISSAGGIO DEL BINARIO
TRACK FIXING ACCESSORIES

BINARI A SUPERFICIE/SOSPESI
SURFACE/SUSPENDED TRACKS

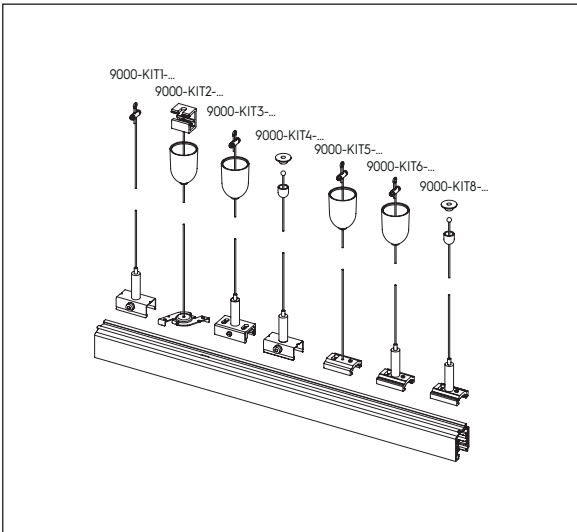

Kit completi per fissaggio a sospensione
Complete suspension kit

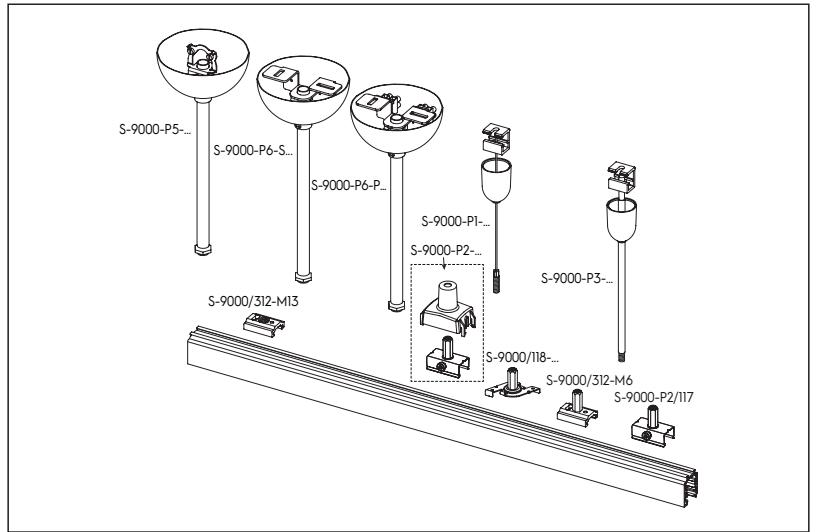

Set per fissaggio a sospensione
Suspension sets

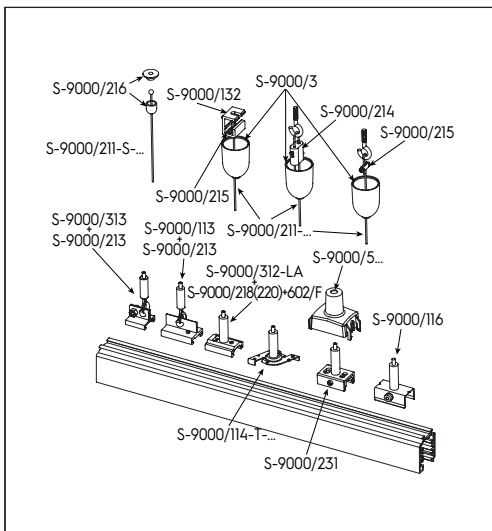

Accessori per sospensione con regolazione a binario
Suspension accessories with track adjustment

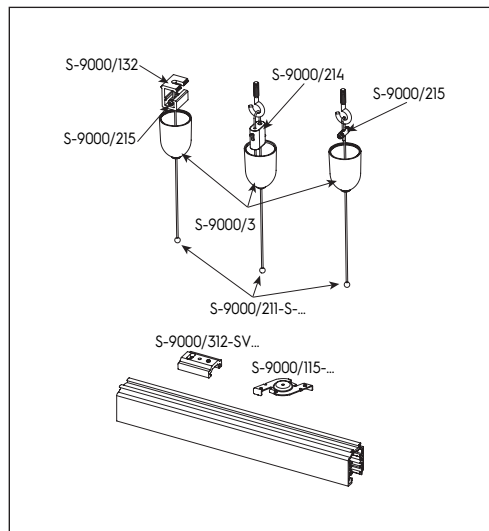

Accessori per sospensione con regolazione a plafone
Suspension accessories with ceiling adjustment

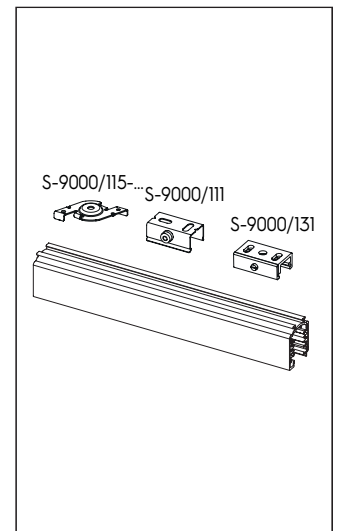

Accessori per fissaggio a plafone
Ceiling fixing accessories

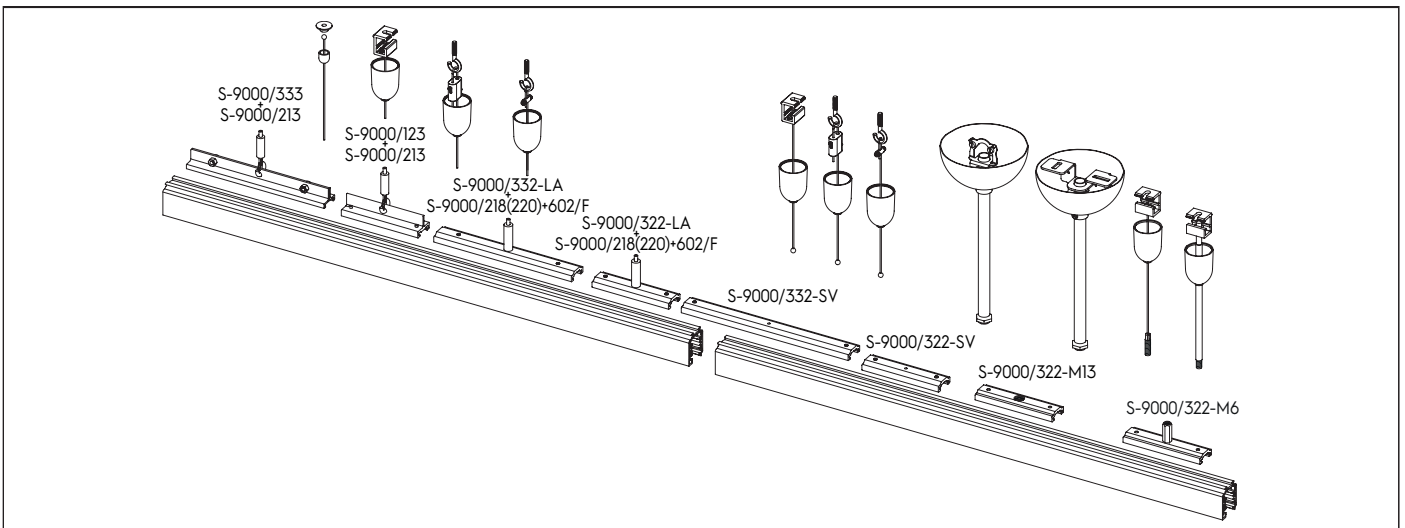

Accessori per giunzioni in fila continua
Accessories for "in row" use junctions

BINARIO ROUND
ROUND TRACK

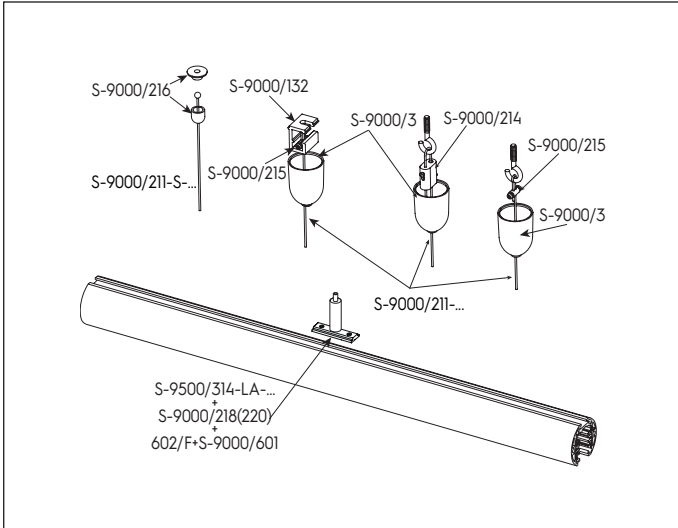

Accessori per sospensione con regolazione a binario
Suspension accessories with track adjustment

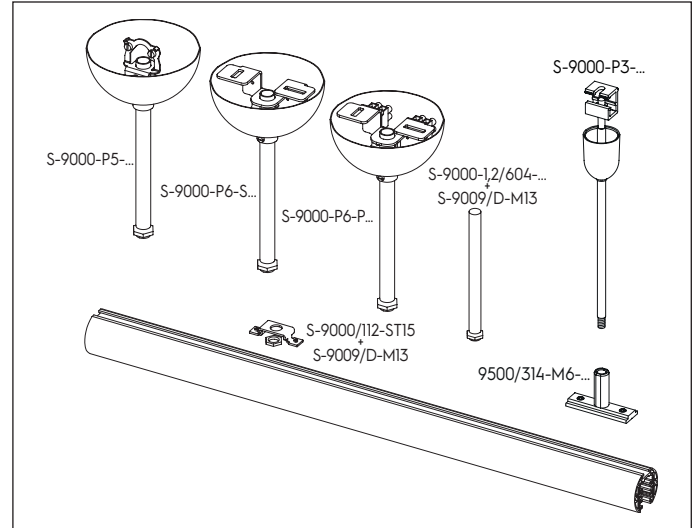

Set per fissaggio rigido a sospensione
Rigid suspension sets

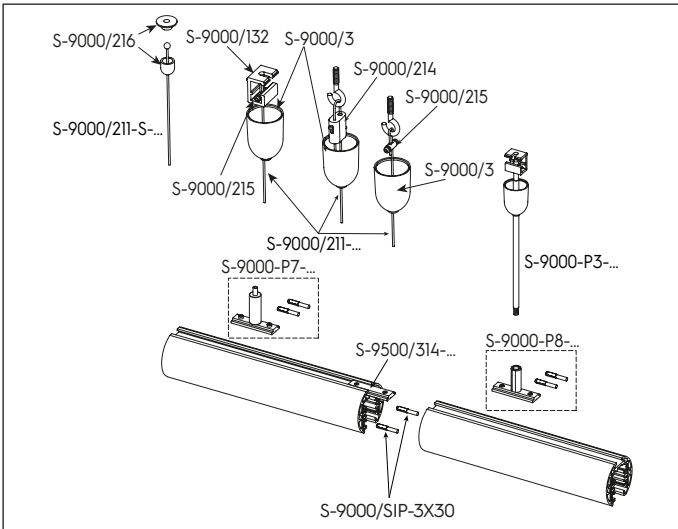

Accessori singoli per giunzioni in fila continua
Single accessories for "in row" use junctions

BINARIO RECESSED
RECESSED TRACK

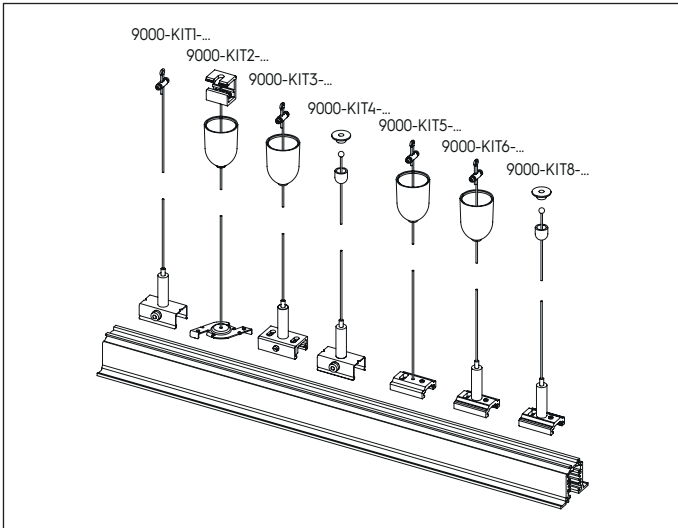

Kit completi per fissaggio a sospensione
Complete suspension kit

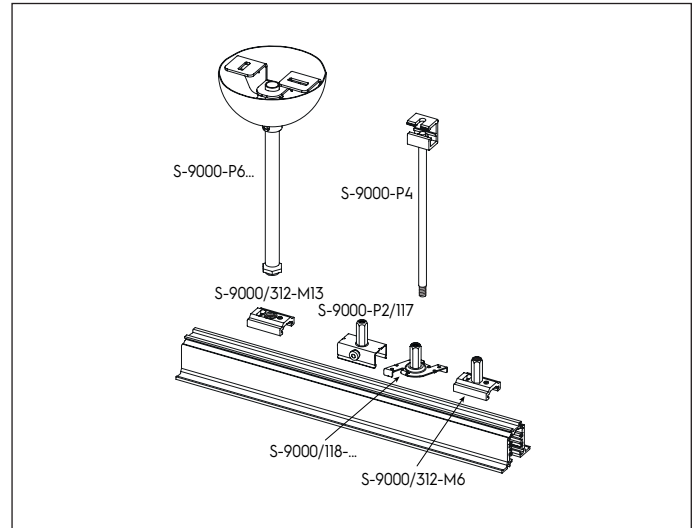

Set per fissaggio a sospensione
Suspension sets

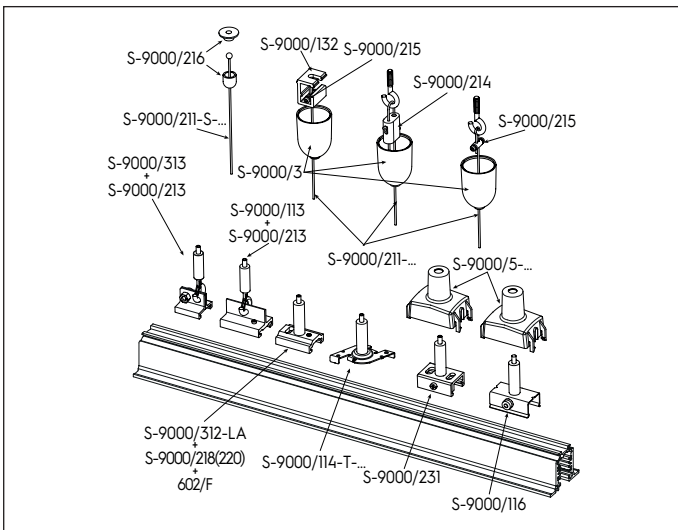

Accessori per sospensione con regolazione a binario
Suspension accessories with track adjustment

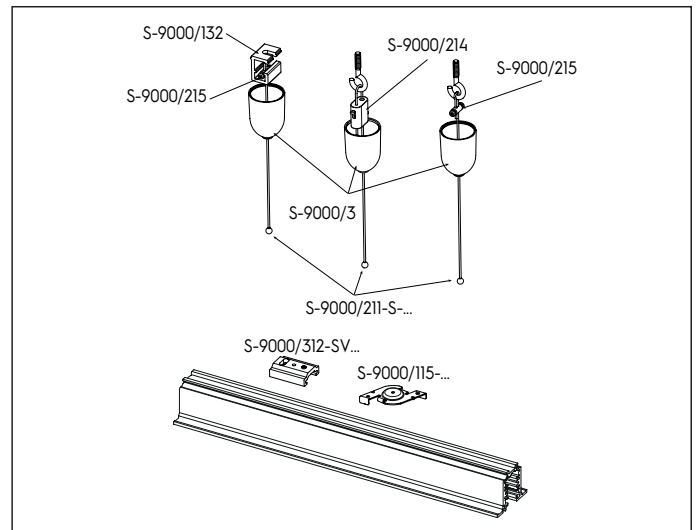

Accessori per sospensione con regolazione a plafone
Suspension accessories with ceiling adjustment

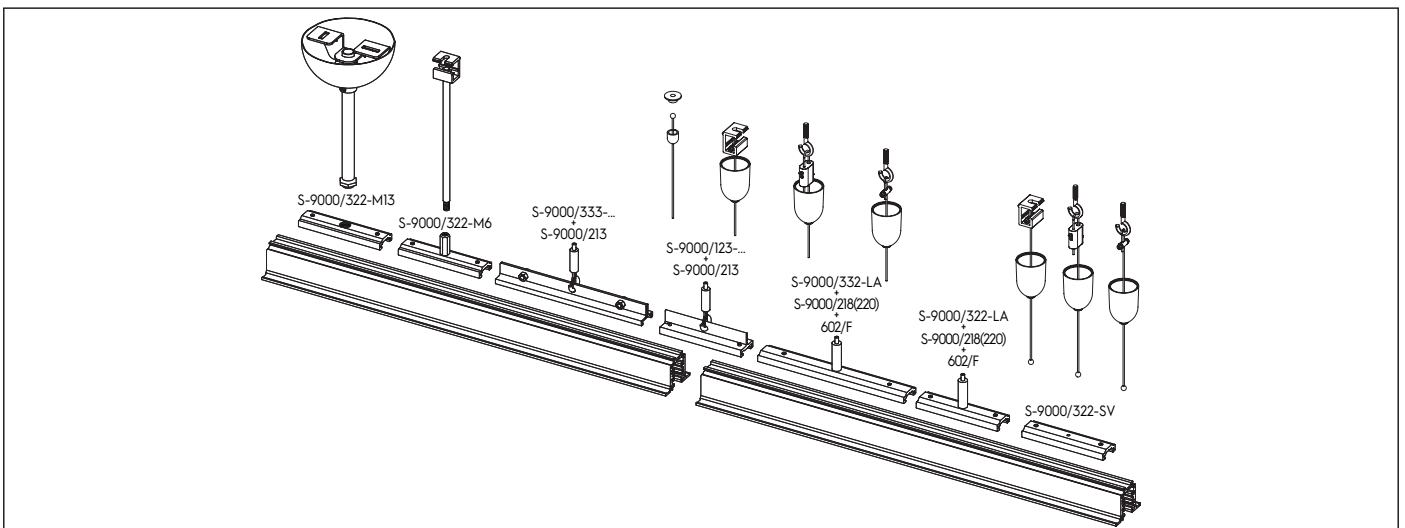

Accessori singoli per giunzioni in fila continua
Single accessories for "in row" use junctions

BINARIO TRIMLESS
TRIMLESS TRACK

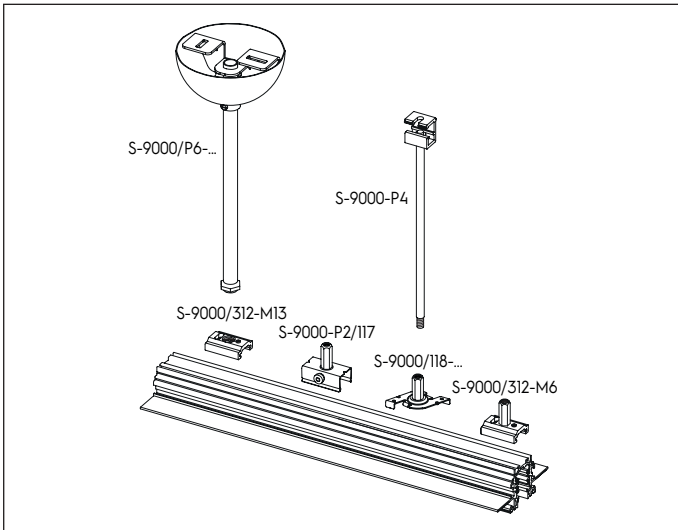

Set per fissaggio a sospensione
Suspension sets

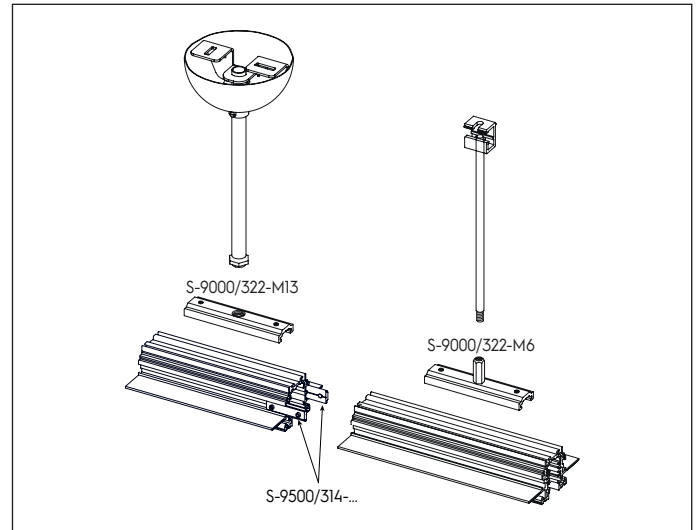

Accessori singoli per giunzioni in fila continua
Single accessories for "in row" use junctions

BINARIO A DOPPIA EMISSIONE
DOUBLE EMISSION TRACK

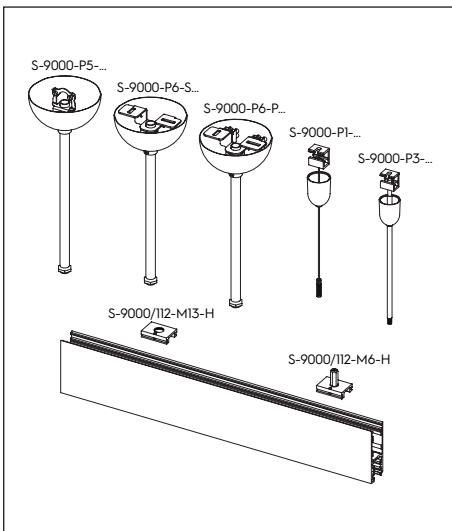

Set per fissaggio a sospensione
Suspension sets

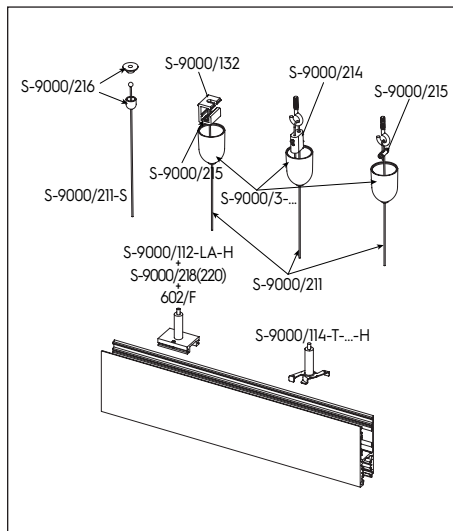

Accessori per sospensione con regolazione a binario
Suspension accessories with track adjustment

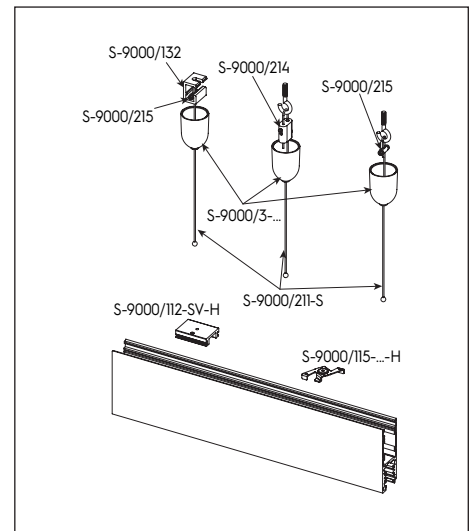

Accessori per sospensione con regolazione a plafone
Suspension accessories with ceiling adjustment

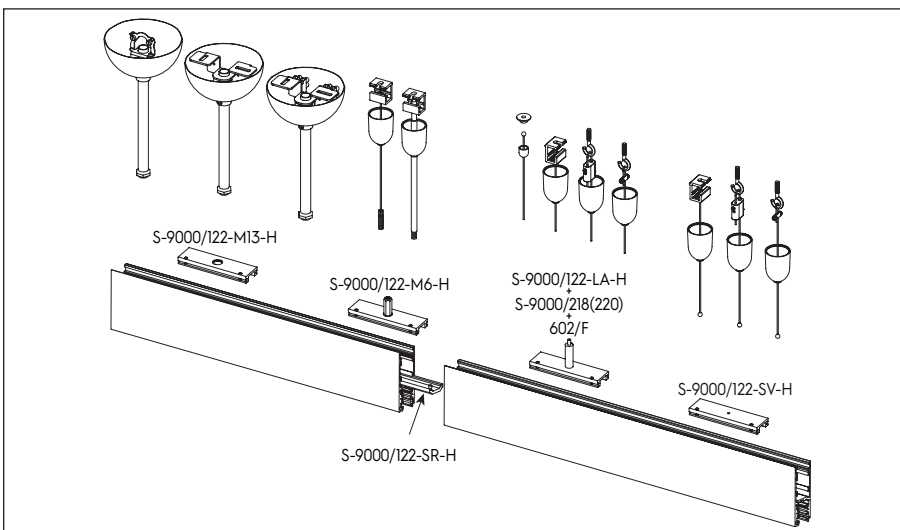

Accessori singoli per giunzioni in fila continua
Single accessories for "in row" use junctions

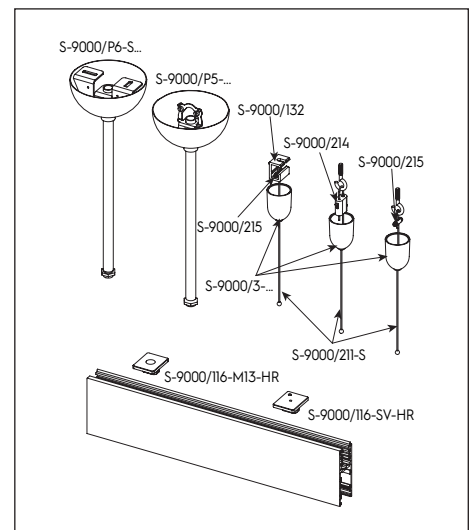

Accessori per utilizzo rovesciato
Accessories for reverse use

KIT COMPLETI PER IL FISSAGGIO A SOSPENSIONE

COMPLETE SUSPENSION KITS

Per binario:
For track:



a superficie/sospeso
surface/suspended



round



recessed



trimless



doppia emissione
double emission

Colori disponibili:
Available colours:



bianco
white RAL 9010



grigio
grey RAL 7035



nero
black RAL 9005



grezzo
raw

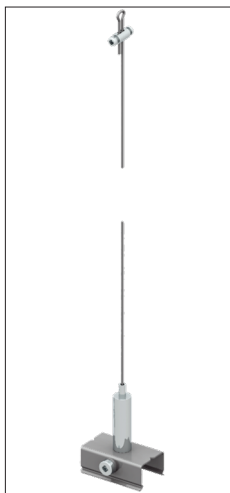

9000-KIT1-1.5
9000-KIT1-3
9000-KIT1-5

Composto da:
· tenditore a vite
· filo in acciaio Ø 1.5mm (L=1500/3000/5000mm)
· clip con tenditore automatico

Composed by:
· screw gripper
· steel cable Ø 1.5mm (L=1500/3000/5000mm)
· clamp with automatic gripper



ST R



9000-KIT2-1.5-...
9000-KIT2-3-...
9000-KIT2-5-...

Composto da:
· staffa per fissaggio a soffitto
· tenditore a vite
· rosone plastico
· filo in acciaio Ø 1.5mm(L=1500/3000/5000mm)
con estremità sferica
· clip per fissaggio rapido

Includes:
· ceiling bracket
· screw gripper
· plastic cup
· steel cable Ø 1.5mm (L=1500/3000/5000mm)
with spherical end
· fast fixing clamp

W G B

ST R



9000-KIT3-1.5-...
9000-KIT3-3-...
9000-KIT3-5-...

Composto da:
· tenditore a vite
· rosone plastico
· filo in acciaio Ø 1.5mm (L=1500/3000/5000mm)
· staffa con tenditore automatico

Includes:
· screw gripper
· plastic cup
· steel cable Ø 1.5mm (L=1500/3000/5000mm)
· bracket with automatic gripper

W G B

ST R

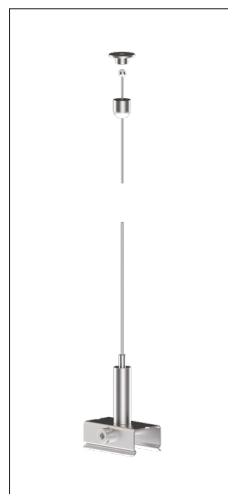

9000-KIT4-1.5
9000-KIT4-3
9000-KIT4-5

Composto da:
· rosone metallico sferico con foro
· filo in acciaio Ø 1.5mm (L=1500/3000/5000mm)
con estremità sferica
· clip con tenditore automatico

Includes:
· round head ceiling attachment
· steel cable Ø 1.5mm (L=1500/3000/5000mm)
with spherical end
· clamp with automatic gripper



ST R



9000-KIT5-1.5-...
9000-KIT5-3-...
9000-KIT5-5-...

Composto da:
· tenditore a vite
· rosone plastico
· filo in acciaio Ø 1.5mm (L=1500/3000/5000mm)
con estremità sferica
· staffa svasata

Includes:
· screw gripper
· plastic cup
· steel cable Ø 1.5mm (L=1500/3000/5000mm)
with spherical end
· flaring bracket

W G B

ST R



9000-KIT6-1.5-...
9000-KIT6-3-...
9000-KIT6-5-...

Composto da:
· tenditore a vite
· rosone plastico
· filo in acciaio Ø 1,5mm (L=1,5/3/5m)
con estremità sferica
· staffa con tenditore automatico

Composed by:
· screw gripper
· plastic cup
· steel cable Ø 1.5mm (L=1500/3000/5000mm)
with spherical end
· bracket with automatic gripper

W G B

ST R



9000-KIT8-1,5 9000-KIT8-1,5-...
 9000-KIT8-3 9000-KIT8-3-...
 9000-KIT8-5 9000-KIT8-5-...

Composto da:
 · rosone metallico sferico con foro
 · filo in acciaio Ø 1.5mm (L=1500/3000/5000mm)
 con estremità sferica
 · staffa con tenditore automatico

Includes:
 · round head ceiling attachment
 · steel cable Ø 1.5mm (L=1500/3000/5000mm)
 with spherical end
 · bracket with automatic gripper



SET PER FISSAGGIO A SOSPENSIONE SUSPENSION SETS

Per binario:
 For track:

| | | | |
|-----------------------------|---|-------------------------------|----------|
| <input type="checkbox"/> ST | a superficie/sospeso surface/suspended | <input type="checkbox"/> ST15 | round |
| <input type="checkbox"/> R | recessed | <input type="checkbox"/> TR | trimless |
| <input type="checkbox"/> H | doppia emissione double emission | | |

Colori disponibili:
 Available colours:

| | | | | | |
|----------------------------|-----------------|----------|----------------------------|---------------|----------|
| <input type="checkbox"/> W | bianco white | RAL 9010 | <input type="checkbox"/> B | nero black | RAL 9005 |
| <input type="checkbox"/> G | grigio grey | RAL 7035 | <input type="checkbox"/> | grezzo raw | |



S-9000-P1-1.5-...; S-9000-P1-3-...;
 S-9000-P1-5-...

Composto da:
 · staffa per fissaggio a soffitto
 · tenditore a vite
 · rosone plastico
 · filo in acciaio Ø 1.5mm (L=1500/3000/5000mm)
 con terminale M6

Includes:
 · ceiling bracket
 · screw gripper
 · plastic cup
 · steel cable Ø 1.5mm (L=1500/3000/5000mm)
 with M6 threaded end



S-9000-P2-...

Composto da:
 · clip con tenditore M6
 · copertura plastica

Includes:
 · clamp with M6 thread gripper
 · plastic cover



S-9000-P3-...

Composto da:
 · staffa per fissaggio a soffitto
 · dado M6
 · rosone plastico
 · barra filettata M6 (L=1000mm)
 con guaina di copertura

Includes:
 · ceiling bracket
 · M6 nut
 · plastic round head
 · M6 threaded bar (L=1000mm)
 with cover strip

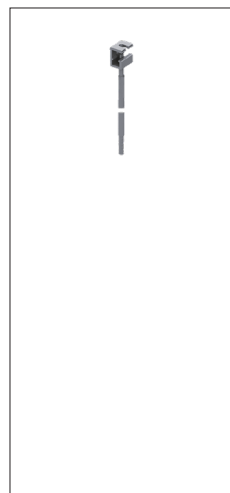

S-9000-P4

Composto da:
 · staffa per fissaggio a soffitto
 · dado M6
 · barra filettata M6 (L=1000mm)

Includes:
 · ceiling bracket
 · M6 nut
 · M6 threaded bar (L=1000mm)





S-9000-P5-B

- Composto da:
- gancio di fissaggio
 - tige metallica (L=2000mm)
 - rosone metallico

- Includes:
- ceiling hook
 - metal stem (L=2000mm)
 - metal cup

W

B

ST

ST15

R

TR

H



S-9000-P6-P-...

- Composto da:
- staffa per fissaggio a soffitto
 - rosone metallico (ø 100mm)
 - tige filettata M13 (L= 1200mm) con controdado estremità sferica
 - 2 morsetti da 2P 400V-32A; T: 125°C; sez. 4mm² + morsetto di terra dedicato

- Includes:
- ceiling bracket
 - metallic cup (ø 100mm)
 - M13 threaded stem (L=1200mm) with counter-nut
 - 2 2P terminal blocks 400V-32A; T: 125°C; sect. 4mm² + dedicated earth terminal block

W

B

ST

ST15

TR

H



S-9000-P6-S-...

- Composto da:
- staffa per fissaggio a soffitto
 - rosone metallico (ø 100mm)
 - tige filettata M13 (L= 1200mm) con controdado

- Includes:
- ceiling bracket
 - metallic cup (ø 100mm)
 - M13 threaded stem (L=1200mm) with counter-nut

W2

B

ST

ST15

R

TR

H



S-9000-P7-...

- Composto da:
- staffa con tenditore automatico
 - 2 spine ad intaglio parziale

- Includes:
- bracket with automatic gripper
 - 2 grooved pins

W2

B

ST15

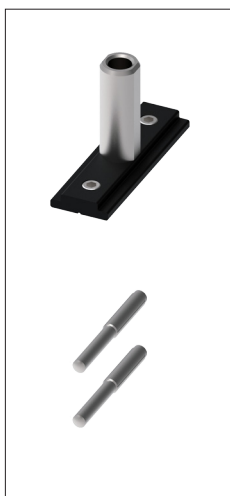

S-9000-P8-...

- Composto da:
- staffa con tenditore M6
 - 2 spine ad intaglio parziale

- Includes:
- bracket with M6 thread gripper
 - 2 grooved pins

W2

B

ST15

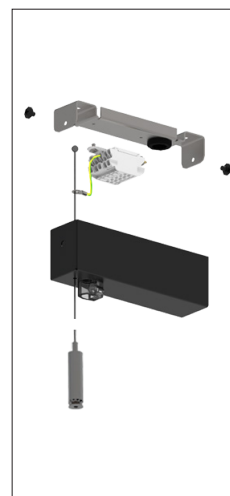

SET-RS/...-3

- Composto da:
- staffa per fissaggio a soffitto
 - 1 morsetto 2675/SP/43 con cavo di terra
 - filo in acciaio ø 1,5mm (L=3m) con estremità sferica
 - rosone metallico
 - tenditore automatico

- Includes:
- ceiling bracket
 - 1 terminal block 2675/SP/43 with earth wire
 - steel cable Ø 1.5mm (L=3m) with spherical end
 - metal cup
 - automatic lock

W2

BG

Effetto gofrato
Embossed effect

ST

ST15

H

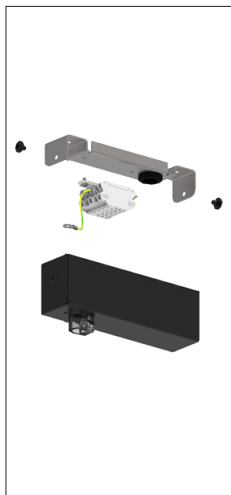

SET-RS/...

Composto da:
 · staffa per fissaggio a soffitto
 · 1 morsetto 2675/SP/43 con cavo di terra
 · rosone metallico

Includes:
 · ceiling bracket
 · 1 terminal block 2675/SP/43 with earth wire
 · metal cup

W2 **BG** Effetto gofrato
 Embossed effect

ST **ST15**

H

ACCESSORI SINGOLI SINGLE ACCESSORIES

Per binario:
 For track:

ST

a superficie/sospeso
 surface/suspended

ST15

round

Colori disponibili:
 Available colours:

W

bianco
 white RAL 9010

W2

nero
 black RAL 9016

R recessed

TR

trimless

H

doppia emissione
 double emission

B nero
 black RAL 9005

G

grigio
 grey RAL 7035

alluminio grezzo
 raw aluminium

ROSONI CUPS



S-9000/3-...

Rosone plastico per filo in acciaio Ø 1.5mm
 Plastic cup for steel cable Ø 1.5mm

W **G** **B**

ST15

R

H



S-9000/4-...

Rosone plastico per barra filettata M6
 Plastic cup for steel M6 threaded bar

W **G** **B**

ST

H



S-9000/6-...

Rosone metallico per barra filettata M13
 Metal cup for steel M13 threaded bar

W **B**

ST

R

TR

ST15

H



S-9000/216

Rosone per fissaggio a soffitto
 Round head ceiling attachment



ST

R

ST15

H

STAFFE PER FISSAGGIO A PLAFONE CEILING FIXING BRACKET

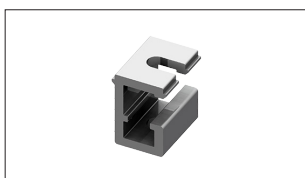

S-9000/132

Staffa per fissaggio a plafone per sospensioni
 Ceiling bracket for suspensions



ST

R

ST15

TR

H

GANCI PER FISSAGGIO A PLAFONE
CEILING FIXING HOOK



S-9000/232

Gancio zincato con foro (Ø13mm) per fissaggio tige
Galvanized hook with fixing hole (Ø13mm) for stem

ST

ST15

H

COPERTURE
COVERS



S-9000/5-...

Copertura plastica per clip e staffe
Plastic cover for clamps and brackets

ST

R

W G B

CLIP
CLAMPS

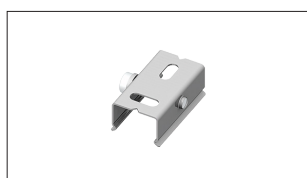

S-9000/111

Clip per fissaggio a soffitto
Ceiling clamp

ST



S-9000/114-T-...

Clip in acciaio verniciato. Tenditore in acciaio nichelato.
Clamp in painted steel. Gripper in nickel-plated steel.

ST

R

W G B



S-9000/114-T-...-H

Clip H in acciaio verniciato. Tenditore in acciaio nichelato
Clamp in painted steel. Gripper in nickel-plated steel

H

W G B



S-9000/115-...

Clip in acciaio verniciato
Clamp in painted steel

ST

R

W G B



S-9000/115-...-H

Clip in acciaio verniciato
Clamp in painted steel

H

W G B

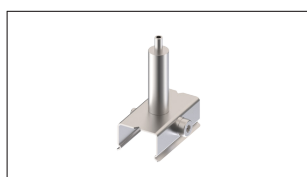

S-9000/116

Clip con tenditore automatico
Clamp with automatic gripper

ST

R

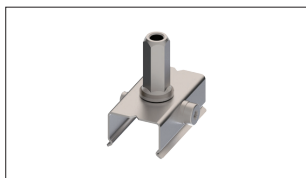

S-9000-P2/117

Clip con tenditore automatico
Clamp with automatic gripper

ST

R

TR



S-9000/118-...

Clip in acciaio verniciato. Tenditore M6 in acciaio nichelato
Clamp in painted steel. M6 threaded gripper in nickel-plated steel

ST

R

TR

W G B



S-9000/119-TB-...

Clip verniciata per fissaggio rapido del binario alla T-bar
Painted fast fixing clamp for fixing the track to the T-bar

ST

W B

STAFFE
BRACKETS



S-9000/112-...-ST15

Staffa per barra rigida
Stem bracket

ST15

W B



S-9000/131
S-9000/131-...

Staffa per fissaggio a plafone
Ceiling bracket

ST

W B

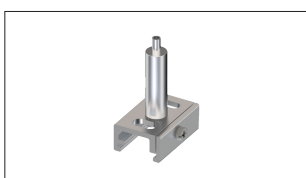

S-9000/231

Staffa con tenditore automatico
Bracket with automatic gripper

ST

R

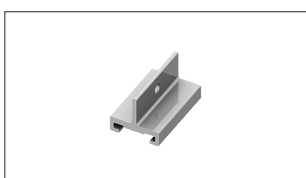

S-9000/113
S-9000/113-...

Staffa a T corta per sospensioni
Short T bracket for suspensions

ST

R

W B



S-9000/123
S-9000/123-...

Staffa a T lunga per sospensioni
Long T bracket for suspensions

ST

R

W B

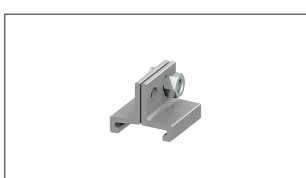

S-9000/313
S-9000/313-...

Staffa a T corta per sospensioni
Short T bracket for suspensions

ST

W B

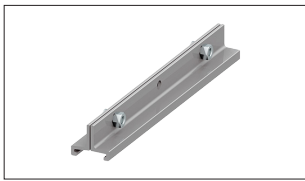

S-9000/333
S-9000/333-...

Staffa a T lunga per sospensioni
Long T bracket for suspensions



ST

R

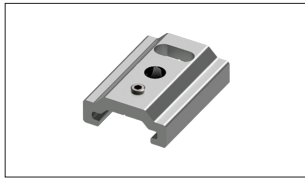

S-9000/312-LA
S-9000/312-LA-...

Staffa corta per sospensioni
Short bracket for suspensions



ST

R

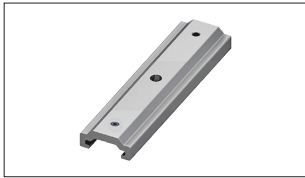

S-9000/322-LA
S-9000/322-LA-...

Staffa media per sospensioni
Medium bracket for suspensions



ST

R



S-9000/332-LA
S-9000/332-LA-...

Staffa lunga per sospensioni
Long bracket for suspensions



ST

R

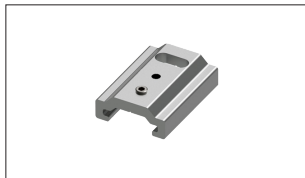

S-9000/312-SV
S-9000/312-SV-...

Staffa corta per sospensioni
Short bracket for suspensions



ST

R



S-9000/322-SV
S-9000/322-SV-...

Staffa media per sospensioni
Medium bracket for suspensions



ST

R



S-9000/332-SV
S-9000/332-SV-...

Staffa lunga per sospensioni
Long bracket for suspensions



ST

R



S-9000/312-M6-...

Staffa corta per sospensioni con tenditore M6
Short bracket with M6 gripper for suspensions



ST

R

TR



S-9000/322-M6-...

Staffa media per sospensioni con tenditore M6
Medium bracket with M6 gripper for suspensions



ST

R

TR



S-9000/312-M13-...

Staffa corta filettata M13 per sospensioni
Short M13 threaded bracket for suspensions



ST

R

TR



S-9000/322-M13-...

Staffa media filettata M13 per sospensioni
Medium M13 threaded bracket for suspensions

W

B

ST

R

TR



S-9500/314-...

Staffa di rinforzo per giunto passante
Reinforcing bracket for jointing connector

W2

B

ST15

TR



S-9500/314-LA-...

Staffa corta per sospensioni
Short bracket for suspensions

W2

B

ST15



S-9500/314-M6-...

Staffa corta per sospensioni con tenditore M6
Short bracket with M6 gripper for suspensions

W2

B

ST15

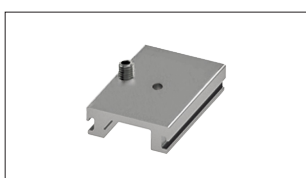

S-9000/112-SV-H

Staffa corta per sospensioni
Short bracket for suspensions



H

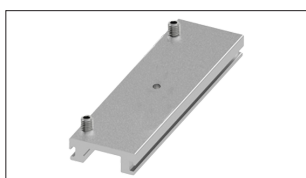

S-9000/122-SV-H

Staffa lunga per sospensioni
Long bracket for suspensions



H



S-9000/112-LA-H

Staffa corta per sospensioni
Short bracket for suspensions



H

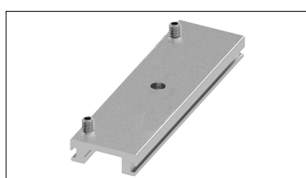

S-9000/122-LA-H

Staffa lunga per sospensioni
Long bracket for suspensions



H

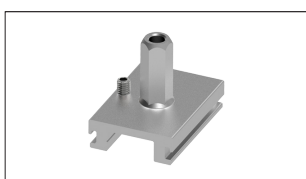

S-9000/112-M6-H

Staffa corta per sospensioni con tenditore M6
Short bracket with M6 gripper for suspensions



H

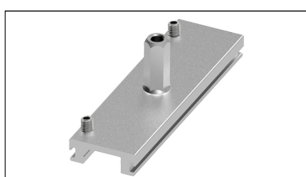

S-9000/122-M6-H

Staffa lunga per sospensioni con tenditore M6
Long bracket with M6 gripper for suspensions



H

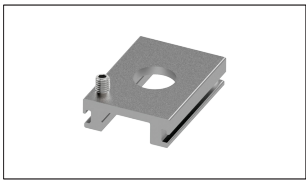

S-9000/112-M13-H

Staffa corta filettata M13 per sospensioni
Short M13 threaded bracket for suspensions



H

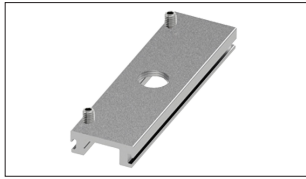

S-9000/122-M13-H

Staffa media filettata M13 per sospensioni
Medium M13 threaded bracket for suspensions



H

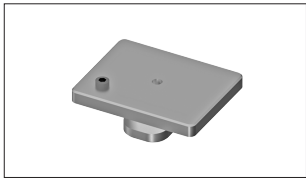

S-9000/116-SV-HR

Staffa corta per sospensioni (utilizzo rovesciato)
Short bracket for suspensions (reverse use)



H

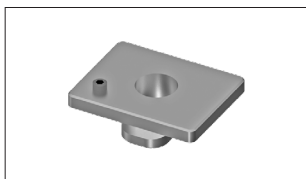

S-9000/116-M13-HR
S-9000/116-M13-...-HR

Staffa corta filettata M13 per sospensioni (utilizzo rovesciato)
Short M13 threaded bracket for suspensions (reverse use)



H

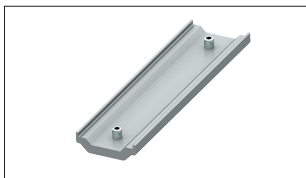

S-9000/122-SR-H

Staffa di giunzione
Joining bracket



H

CAVI
CABLES



S-9000/211-...

Filo in acciaio ø1,5mm (...=L 1500/3000/5000mm)
Steel cable ø 1,5mm (...=L 1500/3000/5000mm)



ST R
ST15 H



S-9000/211-S-...

Filo in acciaio con terminale a sfera ø1,5mm (...=L 1500/3000/5000m)
Steel cable with spherical end ø 1,5mm (...=L 1500/3000/5000m)



ST R
ST15 H

TIGE
STEM



S-9000-1,2/604-...

Tige in ferro verniciato con dado e filetto M13X1 (L=1200mm)
Painted metal stem with M13X1 end + nut (L=1200mm)



ST R
TR
ST15 H

TENDITORI
GRIPPERS



S-9000/213

Tenditore automatico ad uncino
Automatic gripper with lock



ST

R



S-9000/214

Tenditore automatico
Automatic lock



ST

R

ST15

H



S-9000/215

Tenditore a vite
Screw gripper



ST

R

ST15

H



S-9000/218

Tenditore automatico M5 con foro laterale (da usare con vite 602/F fornita separatamente)
Automatic M5 threaded gripper with side hole (to be used with 602/F screw supplied separately)



ST

R

ST15

H



S-9000/220

Tenditore automatico snodato M5 con foro laterale (da usare con vite 602/F fornita separatamente)
Automatic M5 threaded jointed gripper with side hole (to be used with 602/F screw supplied separately)



ST

R

ST15

H



602/F

Vite per il bloccaggio del tenditore sulle staffe LA
Set screw for gripper on the LA brackets



ST

R

ST15

H



S-9000/601

Rosetta elastica dentata M5a
Toothed elastic washer M5a



ST15

SPINE
PINS

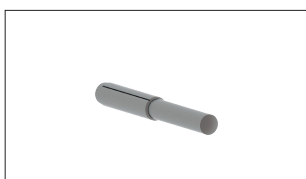

S-9000/SIP-3X30

Spina ad intaglio parziale 3x30
Grooved pin 3x30



ST15

ADATTATORI ADAPTERS

Gli adattatori ONETRACK® hanno un selettore di fase che permette di **mantenere la selezione effettuata** anche se l'adattatore viene spostato e/o reinserito nel binario. Questo permette inoltre di effettuare la selezione di fase **prima del montaggio** semplificando l'operazione.
 Adattatori 9009... e 9209...: carico massimo **100N**. Momento di flessione massimo **5Nm**.
 Adattatori 9409... e 9909...: carico massimo di **50N**. Momento di flessione massimo di **2,5Nm**.

ONETRACK® adapters phase selector allows to **maintain the selected phase** even though the adapter is attached/detached or re-attached to the track. This gives also the possibility to select the phase **before the installation** making it easier.
 9009... and 9209... adapters: maximum load **100N**. Maximum resistance to bending moment **5Nm**.
 9409... and 9909... adapters: maximum load of **50N**. Maximum resistance to bending moment **2,5Nm**.

Per binario: **ST** a superficie/sospeso surface/suspended **ST15** round
 For track: **R** recessed **TR** trimless **H** doppia emissione double emission
 Colori disponibili: **W** bianco white **G** grigio grey **B** nero black
 Available colours:



9009/...

Adattatore simmetrico a 6 conduttori (3 fasi + sistema di controllo)
 Symmetric 6 conductors adapter (3 phase + control system)

W **G** **B**

ST **R**

ST15 **H**

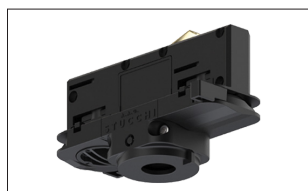

9009-4/...

Adattatore simmetrico a 4 conduttori (3 fasi)
 Symmetric 4 conductors (3 phase) adapter

W **G** **B**

ST **R**

ST15 **H**

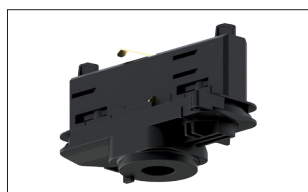

9009/...-HW

Adattatore simmetrico a 6 conduttori (3 fasi + sistema di controllo) con selettore di fase regolabile e leggibile anche di lato
 Symmetric 6 conductors adapter (3 phase + control system) with phase selector and indicator accessible and visible from side of adapter

W **G** **B**

ST **R**

ST15 **H**



9009-4/...-HW

Adattatore simmetrico a 4 conduttori (3 fasi) con selettore di fase regolabile e leggibile anche di lato
 Symmetric 4 conductors (3 phase) adapter with phase selector and indicator accessible and visible from side of adapter

W **G** **B**

ST **R**

ST15 **H**



9209/...

Adattatore asimmetrico a 6 conduttori (3 fasi + sistema di controllo)
 Asymmetric 6 conductors adapter (3 phase + control system)

W **G** **B**

ST **R**

ST15 **H**



9209-4/...

Adattatore asimmetrico a 4 conduttori (3 fasi)
 Asymmetric 4 conductors (3 phase) adapter

W **G** **B**

ST **R**

ST15 **H**



9409-4/...

Adattatore compatto a 4 conduttori (3 fasi)
 Compact 4 conductors (3 phase) adapter

W **G** **B**

ST **R**

ST15 **H**

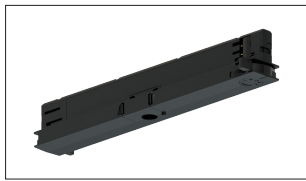

9409-DRI/...-N

Adattatore a 6 conduttori (3 fasi + sistema di controllo) con driver integrato
6 conductors (3 phase+ control system) adapter with integrated driver

W G B

ST R

ST15 H

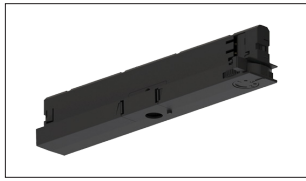

9409-4-DRI/...-S2-N-1

Adattatore a 4 conduttori (3 fasi) con driver integrato
4 conductors (3 phase) adapter with integrated driver

W G B

ST R

ST15 H

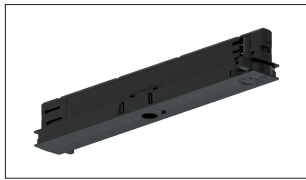

9409-DRI-SM/...-N

Adattatore a 6 conduttori (3 fasi + sistema di controllo) non brandizzato fornito smontato e senza driver
6 conductors (3 phase+ control system) adapter with no brand supplied disassembled and without driver

W G B

ST R

ST15 H

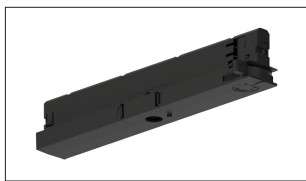

9409-4-DRI-SM/...-N

Adattatore a 4 conduttori (3 fasi) non brandizzato fornito smontato e senza driver
4 conductors (3 phase) adapter with no brand supplied disassembled and without driver

W G B

ST R

ST15 H

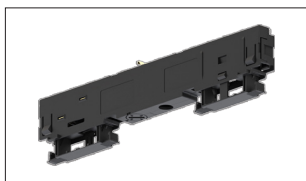

9909-4/...

Adattatore a 4 conduttori (3 fasi)
4 conductors (3 phase) adapter

W B

ST R

TR

ST15 H

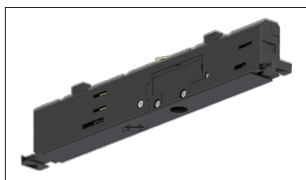

9999/...

Adattatore a scomparsa a 6 conduttori (3 fasi + sistema di controllo)
Concealed 6 conductors adapter (3 phase + control system)

W B

ST R

TR

ST15 H

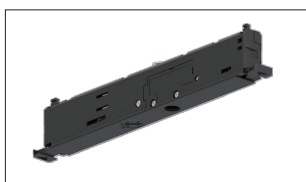

9999-4/...

Adattatore a scomparsa a 4 conduttori (3 fasi)
Concealed 4 conductors adapter (3 phase)

W B

ST R

TR

ST15 H



9999-DRI/...

Adattatore a scomparsa a 6 conduttori (3 fasi + sistema di controllo) con driver integrato
Concealed 6 conductors adapter (3 phase + control system) with integrated driver

W B

ST R

TR

ST15 H

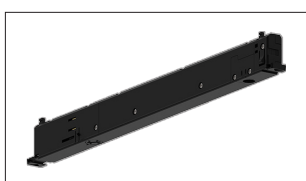

9999-4-DRI/...

Adattatore a scomparsa a 4 conduttori (3 fasi) con driver integrato
Concealed 4 conductors adapter (3 phase) with integrated driver

W B

ST R

TR

ST15 H

ACCESSORI DEGLI ADATTATORI

ADAPTER ACCESSORIES

Colori disponibili: Available colours: W bianco white G grigio grey B nero black grezzo raw



9000/BPU-D...

Basetta per il fissaggio a plafone degli adattatori 9009..., 9209... e 9409-4/... senza l'utilizzo del binario
Base for ceiling fixing of adapters 9009..., 9209... and 9409-4/... without using the track

W B



9000/BRU...

Adattatore per il fissaggio nel controsoffitto della basetta 9000/BPU-...
Adapter for base 9000/BPU-... recessed mounting

W B



S-9000/M-...

Adattatore meccanico
Mechanical adapter

W G B



S-9009/BC...

Bloccacavo esterno con vite in plastica
External cable lock with plastic screw

W G B

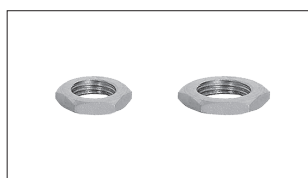

S-9009/D-M10
S-9009/D-M13

Dadi per raccordi (M10/M13)
Nuts for nipples (M10/M13)



S-9009/IP40-...

Carter IP40 per adattatori simmetrici 9009...
IP40 guard for 9009... symmetric adapters

W G B

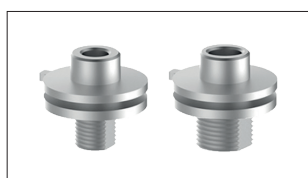

S-9009/M10
S-9009/M13

Raccordi (M10/M13) per adattatori 9009... e 9209...
Nipples (M10/M13) for adapters 9009... and 9209...



S-9009/M10-SC
S-9009/M13-SC

Raccordi (M10/M13) senza collare per adattatori 9009..., 9209... e 9409...
Nipples (M10/M13) without border for adapters 9009..., 9209... and 9409...





S-9009/M10-SC-L
S-9009/M13-SC-L

Raccordi (M10/M13) senza collare E FERMO ANTIROTAZIONE per adattatori S-9000/M-...
Nipples (M10/M13) without collar and anti-rotation pin for adapters S-9000/M-...



S-9009/M10-FI

Raccordo con filetto interno M10 per adattatori 9009..., 9209... e 9409...
Nipples with M10 internal thread for adapters 9009..., 9209... and 9409...

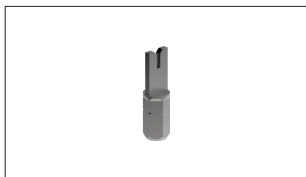

S-9009/T-INS

Inserto per cablaggio adattatori
Installation tool insert for adapter wiring



Immagine esemplificativa
Image for reference only

S-9009/T-HAN

Manico per inserto per cablaggio adattatori
Installation tool handle for adapters wiring



S-9009/10-...

Bloccacavo interno per adattatori simmetrici 9009...
Internal cable lock for 9009... symmetric adapters



S-9209/IP40-...

Carter IP40 per adattatori asimmetrici 9209...
IP40 guard for 9209... asymmetric adapters

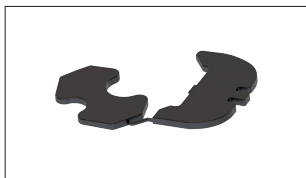

S-9209/20-...

Bloccacavo interno per adattatori asimmetrici 9209...
Internal cable lock for 9209... asymmetric adapters

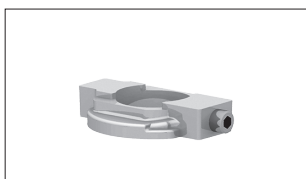

S-9209/51

Anello con grano per il blocco della rotazione del raccordo. Per gli adattatori 9009... , 9209... e S-9000/M-... . Da usare solo con S-9009/M10 e S-9009/M13
Ring with locking grub screw to avoid rotation of the nipple. For adapter 9009... ,9209... e S-9000/M-... . To be used only with S-9009/M10 and S-9009/M13



S-9409/9-B

Bloccacavo interno per adattatori 9409-4...
Internal cable lock for 9409-4... adapters





KIT-9909-ND/M...

Composto da:
 · raccordo (M10/M13) per adattatori 9909-4/... 9999... e 9999-4...
 · rondella antigiro

Composed by:
 · nipple (M10/M13) for adapters 9909-4/... 9999... and 9999-4...
 · Antirotation washer



BOX DRIVER E ACCESSORI
 BOX DRIVER AND ACCESSORIES

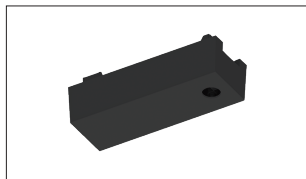

9209/BD-M-...

Box driver LED. Da utilizzare con adattatori asimmetrici 9209...
 LED driver box. To be used with asymmetric adapters 9209...

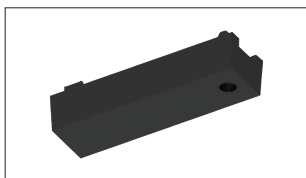

9209/BD-L-...

Box driver LED. Da utilizzare con adattatori asimmetrici 9209...
 LED driver box. To be used with asymmetric adapters 9209...



S-9209-BD/3-...

Copertura plastica e viti per per raccordi box driver LED
 Plastic cover and screws for LED driver box nipples

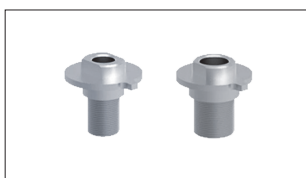

S-9209-BD/M10
 S-9209-BD/M13

Raccordi per box driver LED.
 Nipples for LED driver box.



S-9209-BD-10/4-...

Riduttore per raccordo M10 per box driver LED
 Spacer for LED driver box M10 threaded nipples



S-9209-BD-13/4-...

Riduttore per raccordo M13 per box driver LED
 Spacer for LED driver box M13 threaded nipples





KIT-BD/M10-...

Kit completo per fissaggio M10

Composto da:

- viti di fissaggio
- cover plastica per raccordo
- raccordo in alluminio filettato M10
- riduttore per raccordo M10

Complete kit for M10 fixing

Composed by:

- *fixing screws*
- *plastic cover for nipple*
- *aluminium M10 threaded nipple*
- *spacer for M10 threaded nipple*

W

B



KIT-BD/M13-...

Kit completo per fissaggio M13

Composto da:

- viti di fissaggio
- cover plastica per raccordo
- raccordo in alluminio filettato M13
- riduttore per raccordo M13

Complete kit for M13 fixing

Composed by:

- *fixing screws*
- *plastic cover for nipple*
- *aluminium M13 threaded nipple*
- *spacer for M13 threaded nipple*

W

B

CONNESSIONI ELETTROMECCANICHE ELECTRO-MECHANICAL CONNECTIONS

Tutte le connessioni sono realizzate in policarbonato autoestinguente con glow wire 960°C. Le connessioni sono disponibili in tutte le versioni necessarie per la composizione di un sistema di illuminazione complesso (posizionamento fase interno/esterno, dx/sx, come segnalato nel disegno del singolo articolo dall'apposita linea rossa). Versione per controsoffitto disponibile con l'utilizzo degli appositi accessori.

All connections are made of self-extinguishing polycarbonate, glow wire 960°C. Connections are available in all versions that allow the construction of a complete lighting application (internal/external, R/L phase placement as per red line in the singular drawing). Recessed version available with specific accessories.

Per binario:
For track:

ST

a superficie/sospeso
surface/suspended

ST15

round

Colori disponibili:
Available colours:

W

bianco
white

G

grigio
grey

B

nero
black

R

recessed

TR

trimless

H

doppia emissione
double emission

TESTATE

END FEEDS

—→ polarità - vista dall'alto / polarity ridge - floor view



9001/...
9002/...

Testata
End Feed

W

G

B

ST

R

TR

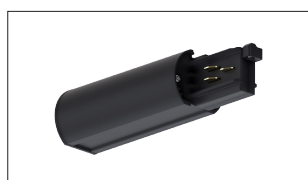
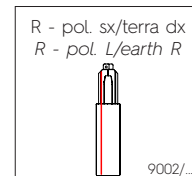
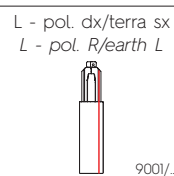

9001-ST15/...
9002-ST15/...

Testata
End Feed

W

B

ST15

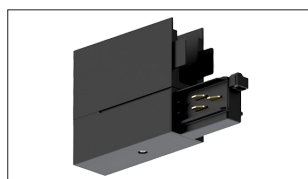
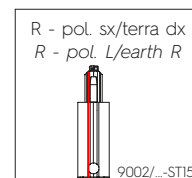
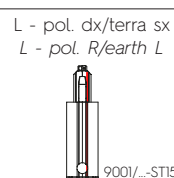

9001/...-H
9002/...-H

Testata
End Feed

W

B

H

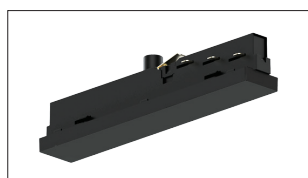
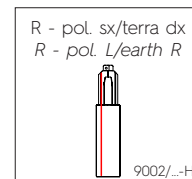
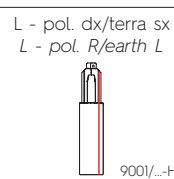

9001/MF-...

Testata intermedia
Middle Feed

W

B

ST

R

ST15

H

CONNESSIONI CONNECTIONS



9003/...

Giunto passante
Joining connector

W

G

B

ST

R

ST15

TR

H

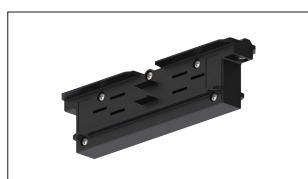

9003/...-M

Connessione isolante
Insulating connection

W

G

B

ST

R

ST15

TR

H

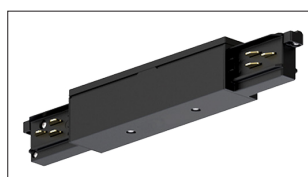

9010/...

Giunto diretto
Middle joint

W

G

B

ST

R

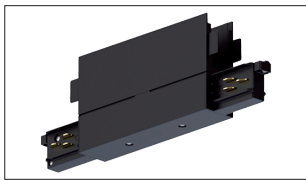

9010/...-H

Giunto diretto per binario H
Middle feed for H track

W B

H



9011/
9012/...

Giunto a L
L-feed

W G B

ST

R

TR

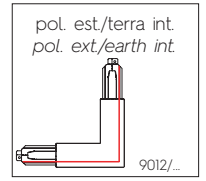
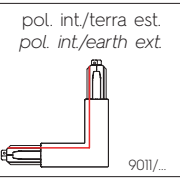

9011-ST15/
9012-ST15/...

Giunto a L
L-feed

W B

ST15

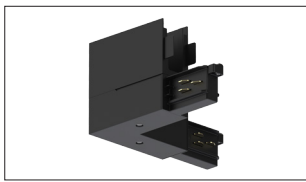
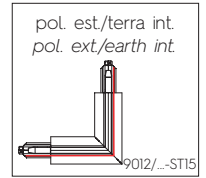
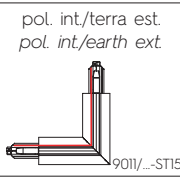

9011/...-H
9012/...-H

Giunto a L per binario H
L-feed for H track

W B

H

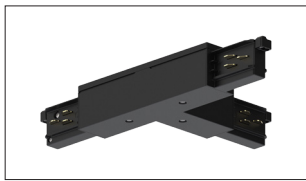
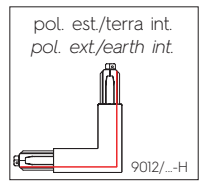
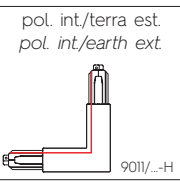

9013/
9014/
9015/
9016/...

Giunto a T
T-feed

W G B

ST

R

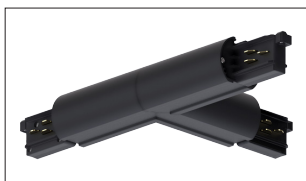
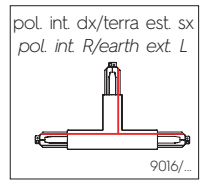
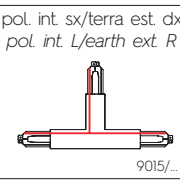
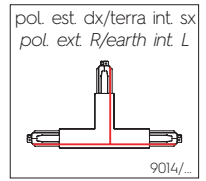
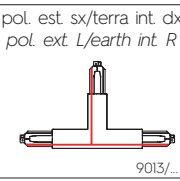

9013-ST15/
9014-ST15/
9015-ST15/
9016-ST15/...

Giunto a T
T-feed

W B

ST15

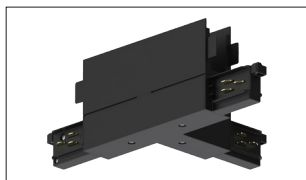
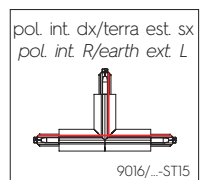
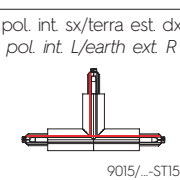
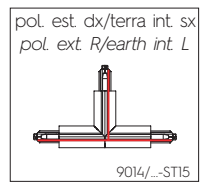
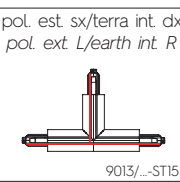

9013/...-H
9014/...-H
9015/...-H
9016/...-H

Giunto a T per binario H
T-feed for H track

W B

H

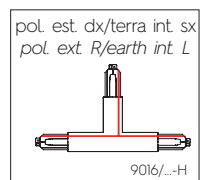
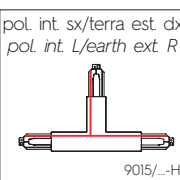
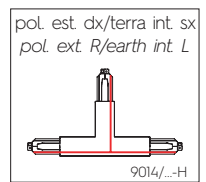
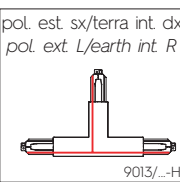



9017/...

Giunto a X
X-feed

W G B

ST

R

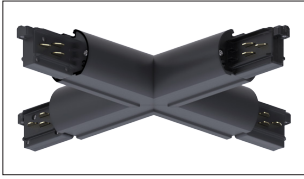

9017-ST15/...

Giunto a X
X-feed

W G B

ST15

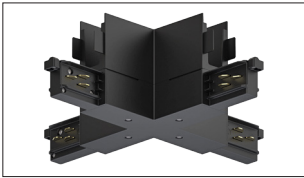

9017/...-H

Giunto a X per binario H
X-feed for H track

W B

H

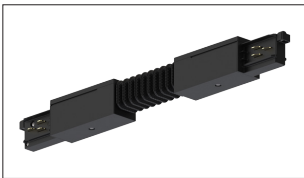

9018/...

Giunto flessibile
Adjustable corner

W G B

ST

R

ACCESSORI CONNESSIONI

CONNECTION ACCESSORIES

Per binario:
For track:

ST

a superficie/sospeso
surface/suspended

ST15

round

Colori disponibili:
Available colours:

W

bianco
white

G

grigio
grey

B

nero
black

R

recessed

TR

trimless

H

doppia emissione
double emission

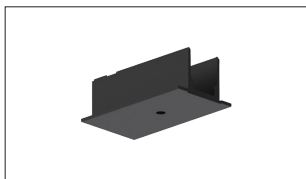

S-9001-R/6-...

Copertura per testata
Cover for end feed

W

G

B

R

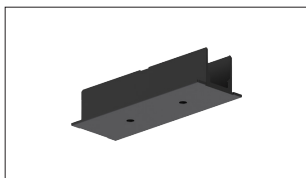

S-9010-R/6-...

Copertura per giunto diretto
Cover for middle feed

W

G

B

R

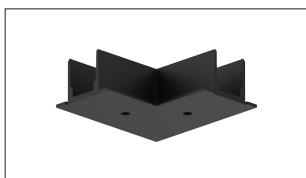

S-9011-R/6-...

Copertura per giunto a L
Cover for L-feed

W

G

B

R

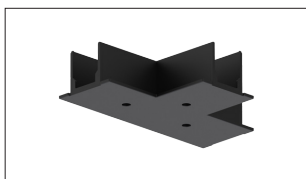

S-9013-R/6-...

Copertura per giunto a T
Cover for T-feed

W

G

B

R

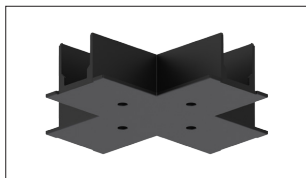

S-9017-R/6-...

Copertura per giunto a X
Cover for X-feed

W

G

B

R



S-9001/TR-...

Copertura per testata
Cover for end feed

W

B

TR



S-9011/TR-...

Copertura per giunto a L
Cover for L-feed

W

B

TR

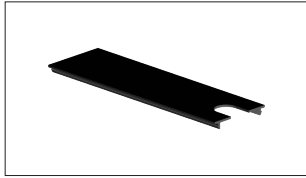

S-9001/H-C3-...-P

Tappo per testata con foro per cavo di alimentazione
End cap for end feed with hole for power cable

W

B

H

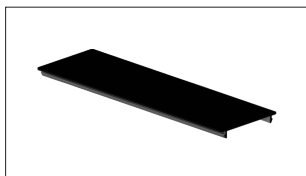

S-9001/H-C3-...

Tappo per testata
End cap for end feed

W

B

H

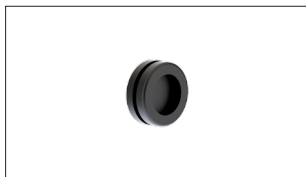

S-9001/115...

Guarnizione per testata di alimentazione.
Gasket for end feed.

W

B

ST

TR

R

H

DISPOSITIVI PER IL CONTROLLO DELLA LUCE
LIGHT CONTROL DEVICES

Colori disponibili: W bianco
Available colours: W white

B nero
black



APPI-M-C0-9009/...

Adattatore per gestione e controllo wireless apparecchi di illuminazione a binari.
Adapter for wireless management and control of track lighting.

Tecnologia / *Technology:* A.A.G. STUCCHI/CASAMBI

W

B

ST

R

ST15

H



APPI-M-S0-9009/...

Adattatore per gestione e controllo wireless apparecchi di illuminazione a binari.
Adapter for wireless management and control of track lighting.

Tecnologia / *Technology:* A.A.G. STUCCHI

W

B

ST

R

ST15

H

ATTENZIONE

Il distributore ha l'obbligo di informare l'utente sulle modalità di utilizzo di tutti i componenti forniti. Materiali, disegni, programma di fabbricazione e confezioni possono subire modifiche o variazioni senza obbligo di preavviso. Si declina ogni responsabilità per eventuali errori di stampa.

WARNING

The manufacturer/distributor must provide its customers with guidance on the correct use of all components supplied. Materials, designs, our development program and packages are subject to changes without notice. We are not responsible for any printing mistakes.

ESEMPI DI COMPOSIZIONE

COMPOSITION EXAMPLES

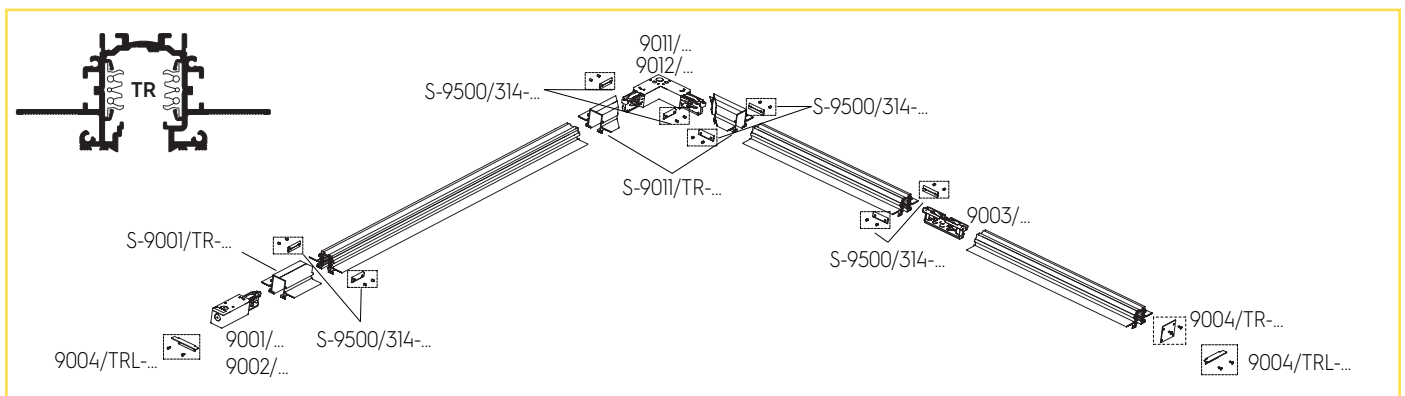
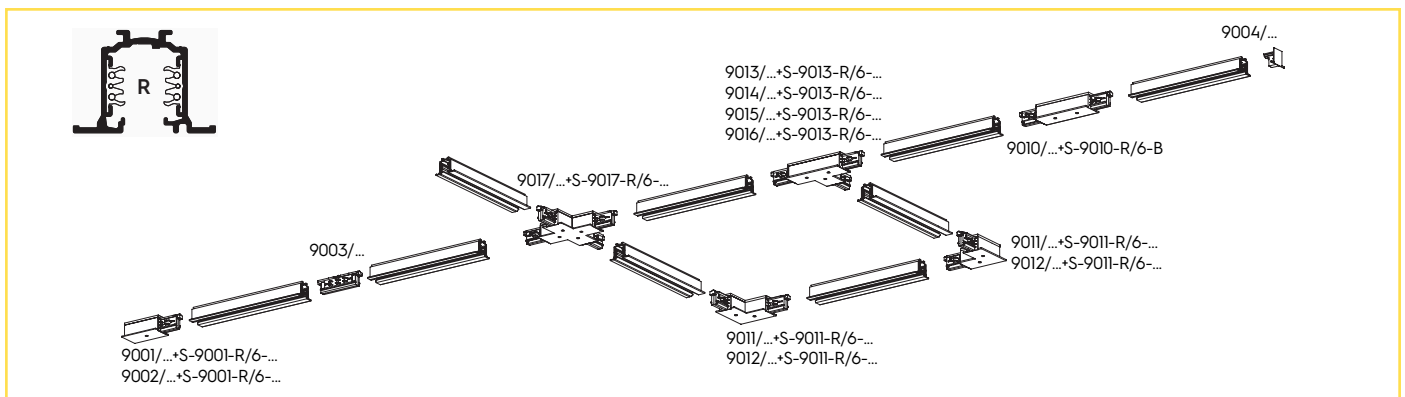
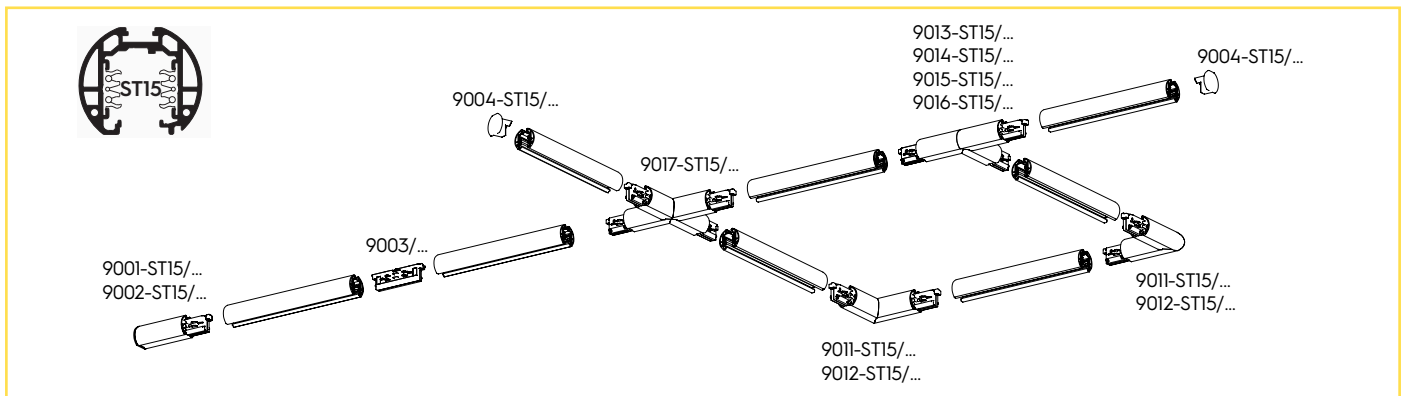
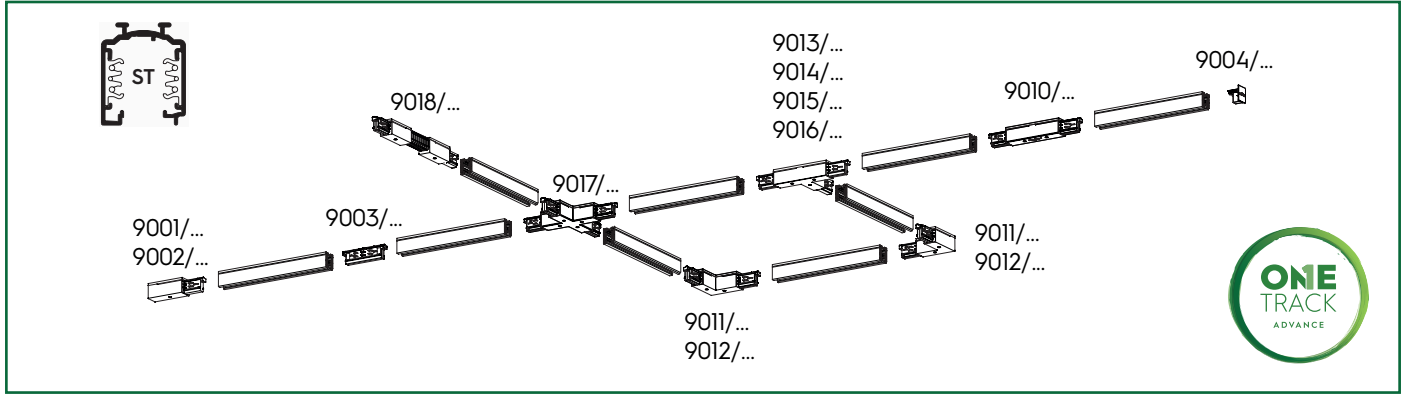

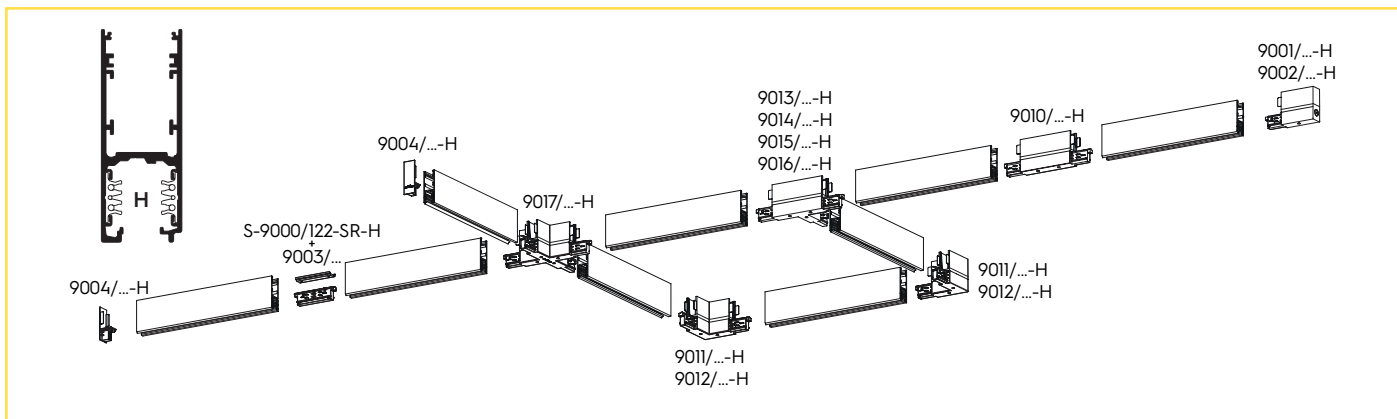

Tutte le operazioni descritte in questo foglio di istruzioni devono essere eseguite da personale specializzato, escludendo tensione dall'impianto e rispettando le norme nazionali di installazione. A.A.G. Stucchi permette solo l'utilizzo dei componenti A.A.G. Stucchi all'interno delle applicazioni che utilizzano il sistema ONETRACK®. Questi componenti devono essere installati secondo le istruzioni di montaggio fornite dall'azienda. L'azienda, come produttrice, non è responsabile della sicurezza e del funzionamento del sistema in caso si utilizzino componenti non appartenenti ad esso o se le istruzioni di montaggio non venissero rispettate. È inoltre responsabilità dell'utente garantire la compatibilità elettrica, meccanica e termica tra il sistema ONETRACK® e gli apparecchi di illuminazione utilizzati. Il binario ed i suoi componenti, compresi gli adattatori, non sono intercambiabili con accessori che non riportino il Marchio di Qualità. Sul binario A.A.G. Stucchi è possibile utilizzare solo le connessioni A.A.G. Stucchi. Le connessioni A.A.G. Stucchi possono essere utilizzate solo su binari A.A.G. Stucchi. Il collegamento elettrico alla rete può essere effettuato soltanto tramite gli art. 9001/..., 9002/... e 9001-MF/... È severamente vietato utilizzare qualsiasi tipo di solvente, colla, olio, sgrassatore o detergente a contatto con tutti i componenti del sistema ONETRACK®. L'azienda non è responsabile di eventuali danni causati dall'utilizzo di suddetti materiali.

All the described operations of this instructions page must be done by specialized personnel only. Exclude voltage plant. Please respect national installation regulations. A.A.G. Stucchi allows to use only A.A.G. Stucchi parts in applications where ONETRACK® system is used. These parts must be installed according to the installation instructions. The company as a manufacturer is not responsible for the safety and functioning of the system if parts not belonging to it are used or if any deviation from the installation instructions occurs. It is then the user's responsibility to ensure the electrical, mechanical and thermal compatibility between the system and the fixtures used with it. The track, its components and also the adapters can't be used with accessories without the Quality Mark. On A.A.G. Stucchi track one can use only A.A.G. Stucchi connections. A.A.G. Stucchi connections can be used only with A.A.G. Stucchi tracks. The track is to be connected to electrical power by means of the A.A.G. Stucchi articles 9001/..., 9002/... and 9001-MF/... It is strictly forbidden to use any kind of solvent, glue, oil, grease or cleaner in contact with ONETRACK® components. The company is not responsible of any damage caused by the use of the materials mentioned above.

CHIAVI MECCANICHE

Il profilo del binario ha una chiave meccanica per rispettare il giusto collegamento tra gli spezzoni di binario.

Anche le testate ed i giunti di collegamento presentano una chiave meccanica (presenza vite - vedi figura sotto) che deve essere tenuta in considerazione per la scelta del giusto componente.

Nei disegni di catalogo di questi accessori il posizionamento della chiave meccanica è evidenziato da una linea rossa.

MECHANICAL KEYS

There a mechanical key on the track to guarantee the proper connection of multiple pieces of track. This key is present on all end-feeds and connecting components (see screw below-pictured). Care must be taken when ordering to select the correct components. The catalog drawing depict the position of the key with a red line.

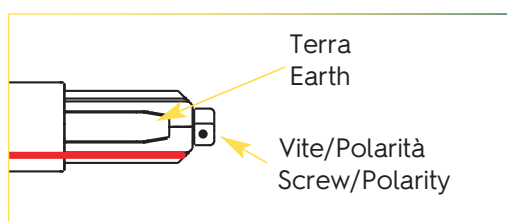

A.A.G. STUCCHI s.r.l. u.s.
Via IV Novembre 30/32, 23854
Olginate (LC) - ITALY
Ph. +39-0341-653111
Fax +39-0341-653250
info@aagstucchi.it

A.A.G. STUCCHI NORTH AMERICA, INC.
5080 North Royal Atlanta Drive
Tucker, GA 30084 - USA
Ph. +1-404-806-5399
northamerica@aagstucchi.com

A.A.G. STUCCHI ASIA PACIFIC LTD.
Regional office
Room 01, 11/fl., New Treasure Centre
N° 10 Ng Fong Street, Kowloon - HONG KONG
Ph. +852-2578-8988
Fax +852-2571-5039
hongkong@aagstucchi.hk

A.A.G. STUCCHI SHANGHAI LTD.
Rm 3007, N°738, Chang Yang Rd
YangPu area, 200082 - SHANGHAI
Ph. +86-21-51816507
Fax +86-21-51816508
east@aagstucchi.hk

Per maggiori informazioni riguardanti i prodotti A.A.G. Stucchi visitate il sito www.aagstucchi.it
o il virtual tour del nostro showroom inquadrando il QR Code a fianco.

*For more info regarding A.A.G. Stucchi products please visit our website www.aagstucchi.it
or see our showroom virtual tour by scanning the QR Code next.*



Aggiornamento Febbraio 2023
February 2023 update