

lio

light inside Onetrack



A. A. G.
STUCCHI





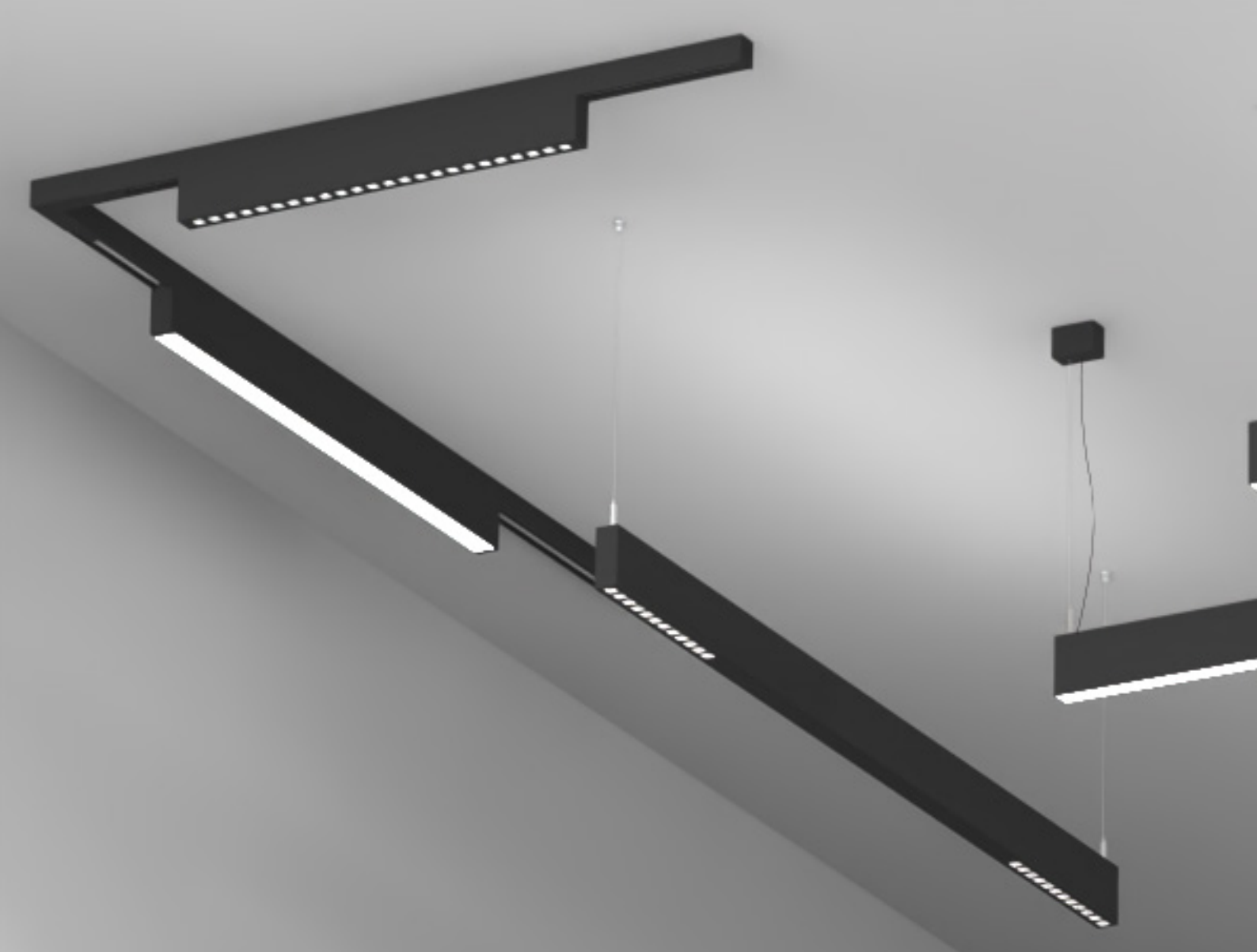

A.A.G. Stucchi propone diverse soluzioni per creare luce lineare all'interno dei binari ONETRACK™:

MODULINE M32: moduli di luce lineare per luce diretta pronti all'uso, facili da installare grazie all'apposito adattatore che garantisce allo stesso tempo una connessione elettrica sicura mentre i tappi di chiusura assicurano la massima sicurezza di installazione.

MODULINE M32 è disponibile sia in moduli di luce pronti all'uso, che come sistema di componenti meccanici da assemblare e personalizzare a livello illuminotecnico.

H32: sistema di luce lineare DOWNLIGHT e UPLIGHT realizzato con binario biemissione, pensato anche per utilizzo in fila continua.

L32: è un sistema di luce lineare standalone, non legato alla presenza del binario ma che ne utilizza la stessa logica in termini di modularità, flessibilità e versioni disponibili per adattarsi a tutti i progetti di illuminazione.

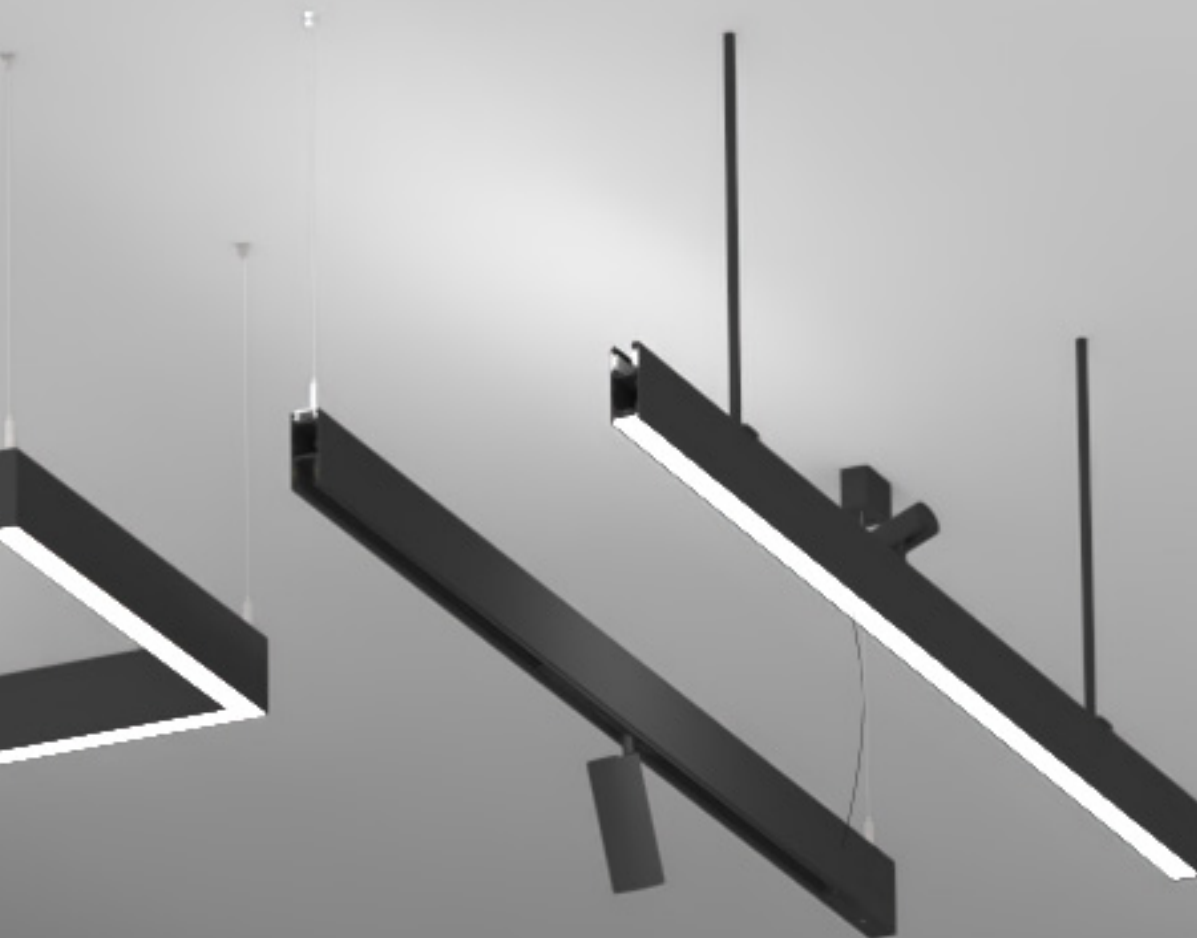

A.A.G. Stucchi offers different solutions to make linear light possible inside ONETRACK™ system:

MODULINE M32: *“ready to use” linear light modules that are easy and fast to install inside tracks thanks to the specific adapter that guarantees safe electrical connection. The special caps ensure maximum safety in installation.*

MODULINE M32 is available as “ready to use” lighting modules but also as a system of mechanical components to be assembled and customized in lighting fixtures.

H32: *DOWNLIGHT and UPLIGHT linear light system made with biemission tracks, suitable for in row use.*

L32: *A linear lighting standalone system with the same approach in terms of modularity, flexibility and available versions, to be suitable for all lighting projects.*

INDICE

INDEX

INTRODUZIONE / INTRODUCTION

CARATTERISTICHE GENERALI / *GENERAL FEATURES* 8

H32

APPLICAZIONI / *APPLICATIONS* 10

CONFIGURATORE CODICI PRODOTTO / *PRODUCT CODE CONFIGURATOR* 12

DATI TECNICI E PERFORMANCE DI PRODOTTO / *TECHNICAL DATA AND PRODUCT PERFORMANCE* 14

ACCESSORI / *ACCESSORIES* 16

MODULINE M32

APPLICAZIONI / *APPLICATIONS* 20

CONFIGURATORE CODICI PRODOTTO / *PRODUCT CODE CONFIGURATOR* 22

COMPOSIZIONE MECCANICA E COMPONENTI SINGOLI / *MECHANICAL COMPOSITION AND SINGLE COMPONENTS* 24

PERFORMANCE DI PRODOTTO / *PRODUCT PERFORMANCE* 29

DATI TECNICI RANGE DI PRODOTTO / *PRODUCT RANGE TECHNICAL DATA* 31

L32

APPLICAZIONI / <i>APPLICATIONS</i>	33
CONFIGURATORE CODICI PRODOTTO / <i>PRODUCT CODE CONFIGURATOR</i>	35
PERFORMANCE DI PRODOTTO / <i>PRODUCT PERFORMANCE</i>	37
DATI TECNICI RANGE DI PRODOTTO / <i>PRODUCT RANGE TECHNICAL DATA</i>	41
ACCESSORI / <i>ACCESSORIES</i>	44
L32 - L SHAPE	48
INFO TECNICHE / <i>TECHNICAL INFO</i>	49
CONFIGURATORE CODICI PRODOTTO / <i>PRODUCT CODE CONFIGURATOR</i>	50
PERFORMANCE DI PRODOTTO / <i>PRODUCT PERFORMANCE</i>	52
DATI TECNICI RANGE DI PRODOTTO / <i>PRODUCT RANGE TECHNICAL DATA</i>	54
ACCESSORI / <i>ACCESSORIES</i>	56

CARATTERISTICHE GENERALI

UN PRODOTTO FLESSIBILE

MODULINE M32 e **H32** sono prodotti di luce lineare pensati per darti un panorama di soluzioni adatte ad ogni esigenza progettuale con illuminazione a binario 230V, mentre **L32** è un sistema di luce lineare standalone indipendente, che non necessita di una struttura di binari.

Le tre gamme di prodotto con le diverse lunghezze disponibili, la possibilità di utilizzo in fila continua per H32 e L32, insieme alla possibilità di scelta tra le versioni non dimmerabili o dimmerabili, ne garantiscono la massima flessibilità di utilizzo.

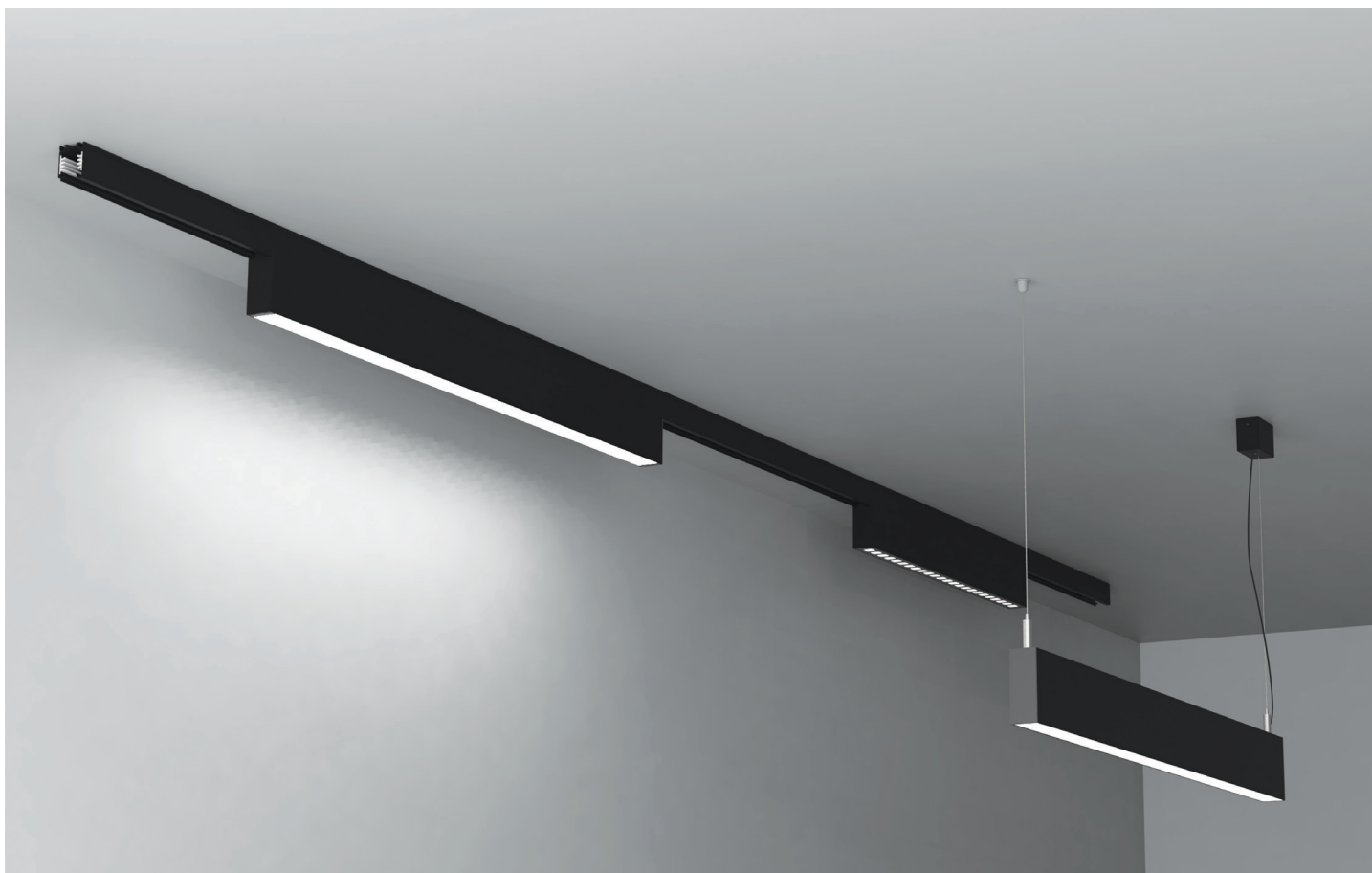

GENERAL FEATURES

A FLEXIBLE PRODUCT

MODULINE M32 and **H32** are the linear light range developed to give you a wide range of solutions for your track lighting projects, both for 230v tracks while **L32** is a standalone linear lights system.

The different available lengths, the possibility to build a continuous line for H32 and L32, the chance to choose among dimmerable and non dimmerable versions make them a very flexible product range.

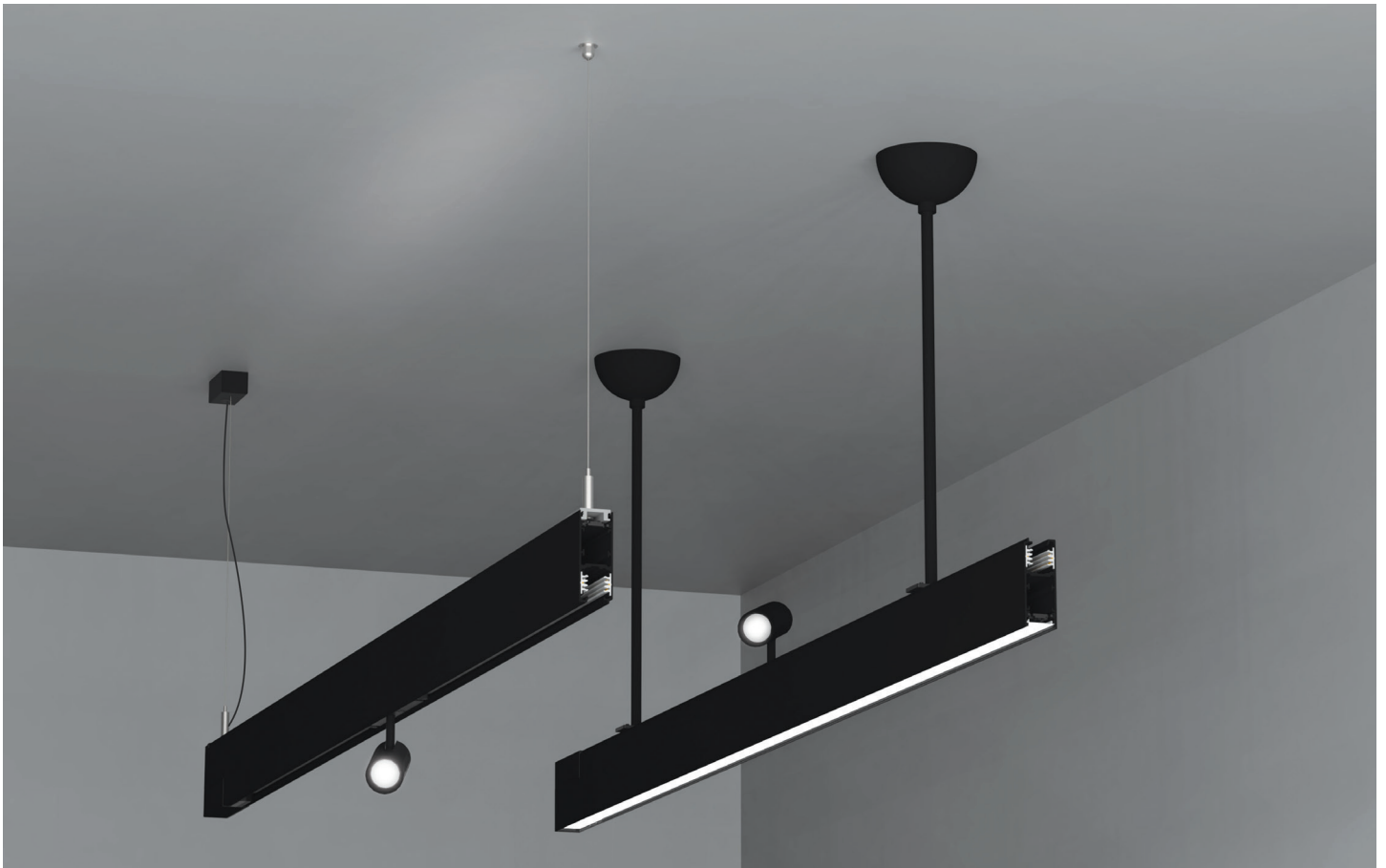

H32

H32 nella sua versione UP può essere utilizzato in fila continua per creare un rettangolo luminoso dove la luce diffusa è indiretta ed uniforme mentre i dettagli vengono illuminati da faretti che possono essere spostati a seconda delle necessità.

H32 in its UP version used "in row" can be used to create a luminous rectangle in which diffuse light is indirect and homogeneous while details are enlightened by spotlights that can be moved as per need.

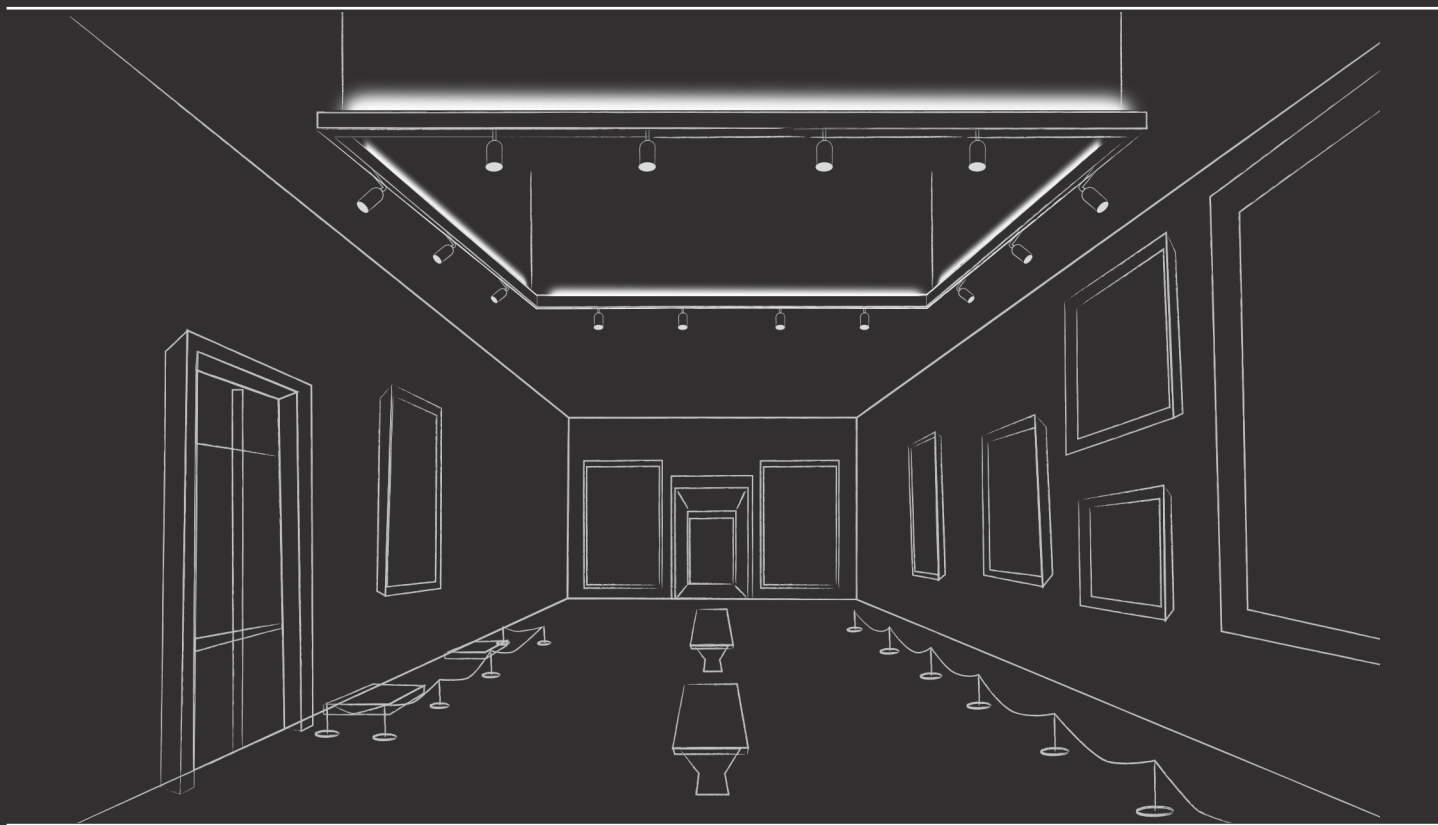

H32 UP

H32 nella sua versione DOWN è ideale per creare luce diffusa ad esempio nel settore retail demandando la luce puntuale ai faretti.

H32 in its DOWN configuration is ideal to be used for diffused light for example in retail applications, demanding accent light to spots.



H32 DOWN

CONFIGURATORE CODICE

CODE CONFIGURATOR

Codice di esempio / Code example

H32S1405/B5-O-2

↓ ↓ ↓ ↓ ↓ ↓ ↓
1 2 3 4 5 6 7

1 - PREFISSO / PREFIX

H32

2 - APPLICAZIONE / APPLICATION

S

Starter

C

Continuous

3 - MISURA / LENGTH

1405 mm

2810 mm

4 - COLORE / COLOUR

B

Nero / Black

RAL 9005

W

Bianco / White

RAL 9010

5 - CARATTERISTICHE LUCE / LIGHT FEATURES

5

3000K CRI 90

6 - SCHERMI / SCREENS

Opalino
Opal

7 - DRIVER

ON - OFF DALI SELV

ESEMPI / EXAMPLES

H32S1405/W5-O-2

H32 | L=1405mm | Bianco | 3000K CRI 90 | Opalino | DALI SELV
H32 | L=1405mm | White | 3000K CRI 90 | Opal | DALI SELV

H32C2810/B5-O-0

H32 | L=2810mm | Nero | 3000K CRI 90 | Opalino | ON-OFF
H32 | L=2810mm | Black | 3000K CRI 90 | Opal | ON-OFF

H32

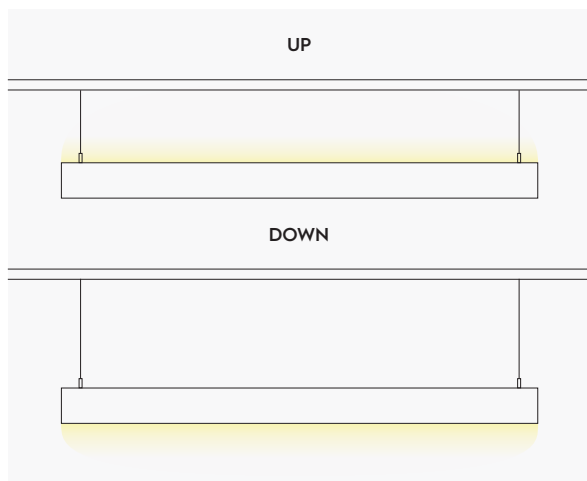
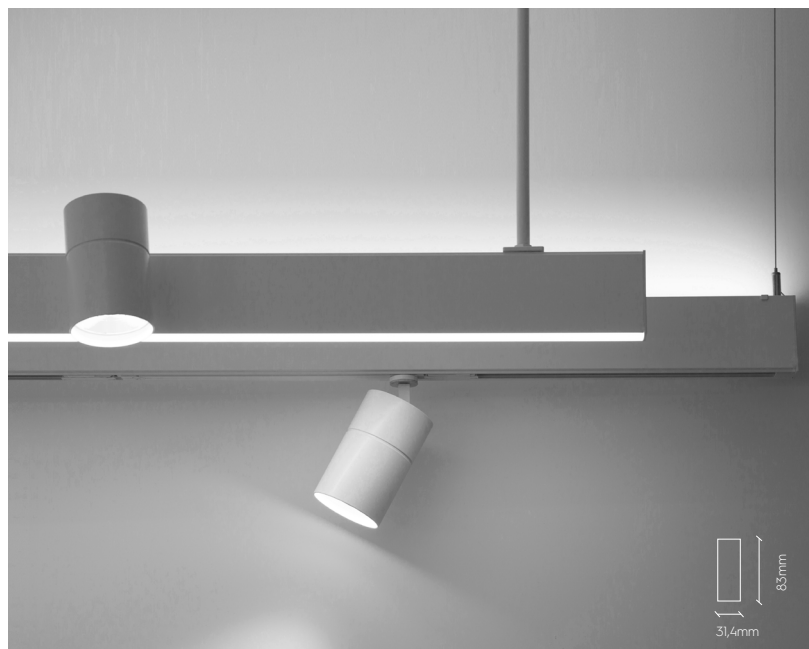

220/240V

IP20

RG0
at 1,2m



Lunghezze disponibili (mm) / Available lengths (mm)

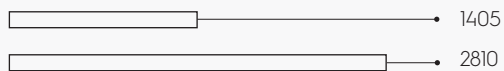

Colori disponibili / Available colours

■ Nero / Black

□ Bianco / White

Temperatura colore (K) / Colour temperature (K)

3000

CRI

≥90

DATI TECNICI RANGE DI PRODOTTO

PRODUCT RANGE TECHNICAL DATA

STARTER

[mm]	n°. LED Mod	[K]	I LED [mA]	FLUSSO NOMINALE [lm] NOMINAL FLUX [lm]	FLUSSO REALE [lm] REAL FLUX [lm]	POTENZA [W] POWER [W]	POTENZA LED [W] POWER LED [W]	V _F	CRI	SDCM	LIFETIME [Khr]
1405	5	3000	700	4080	2384	34,5	30,5	~ 45	≥90	≤3	>50Khr L90B5
2810	10	3000	1400	8160	4769	69,2	61,0	~ 45	≥90	≤3	>50Khr L90B5

CONTINUOUS

[mm]	n°. LED Mod	[K]	I LED [mA]	FLUSSO NOMINALE [lm] NOMINAL FLUX [lm]	FLUSSO REALE [lm] REAL FLUX [lm]	POTENZA [W] POWER [W]	POTENZA LED [W] POWER LED [W]	V _F	CRI	SDCM	LIFETIME [Khr]
1405	5	3000	700	4080	2384	34,5	30,5	~ 45	≥90	≤3	>50Khr L90B5
2810	10	3000	1400	8160	4769	69,2	61,0	~ 45	≥90	≤3	>50Khr L90B5

Luce up / Up light

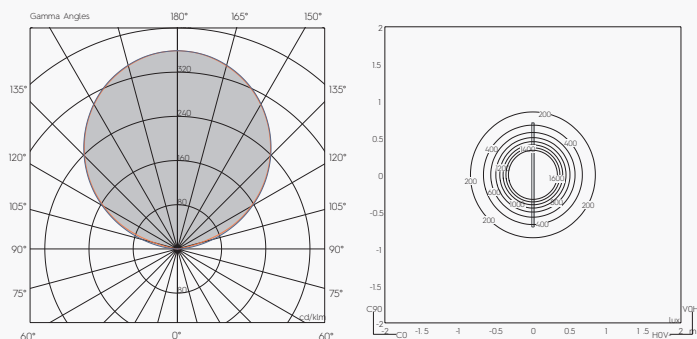

Room (m): 4x4x3h H luminaire (m): 2,5
Ref. surface: ceiling

Luce down / Down light

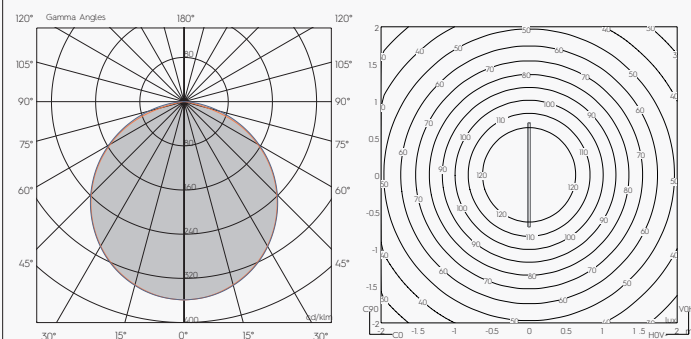

Room (m): 4x4x3h H luminaire (m): 2,5
Ref. surface: floor

Dati riferiti ad apparecchi di colore nero. Finitura bianca= +12% circa sul flusso indicato / lm= real flux. Datas refer to black colour fixtures. White color= about +12% on the real flux

ACCESSORI H32 UP

H32 UP ACCESSORIES

ACCESSORI / ACCESSORIES



9004/...-H

Tappo di chiusura con vite di blocco
End-Cap with locking screw



9003/...

Giunto passante
Joining connector



S-9000/122-SR-H

Staffa di giunzione
Joining bracket

ACCESSORI DI FISSAGGIO / FIXING ACCESSORIES

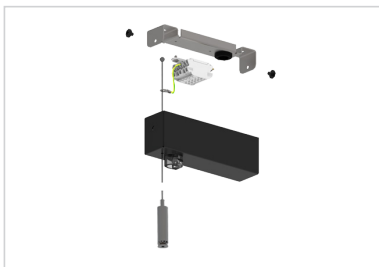

SET-RS-...-3

Set per fissaggio a soffitto
Set for ceiling mounting



S-9000/211-...

Cavo in acciaio
Steel cable



S-9000/215

Tenditore a vite
Screw gripper



S-9000/211-S-...

Cavo in acciaio con sfera
Steel cable with spherical end



S-9000/216

Rosone per fissaggio a soffitto
Round head ceiling attachment



S-9000/114-T-...-H

Clip con tenditore per fissaggio rapido del binario H
H track fast fixing clamp with gripper

ACCESSORI H32 DOWN

H32 DOWN ACCESSORIES

ACCESSORI / ACCESSORIES



9004/...-H

Tappo di chiusura con vite di blocco
End-Cap with locking screw



9003/...

Giunto passante
Joining connector



S-9000/122-SR-H

Staffa di giunzione
Joining bracket

SET E ACCESSORI DI FISSAGGIO / FIXING SETS AND ACCESSORIES



S-9000/P6-S...

Set per fissaggio a sospensione
Suspension set



S-9000/P5-...

Set per fissaggio a sospensione
Suspension set

ACCESSORI DI FISSAGGIO SINGOLI / SINGLE FIXING ACCESSORIES

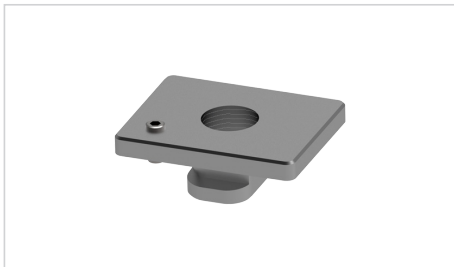

S-9000/116-M13-HR

Staffa corta filettata M13 per sospensioni
Short M13 threaded bracket for suspensions

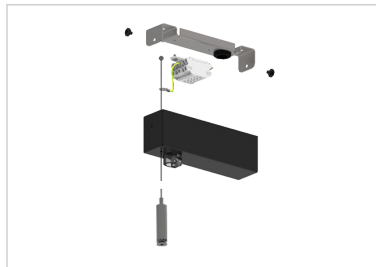

SET-RS-...-3

Set per fissaggio a soffitto
Set for ceiling mounting

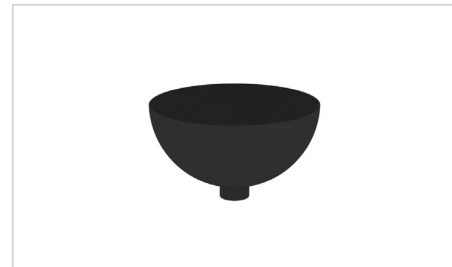

S-9000/6-...

Rosone metallico per barra filettata M13
Metal cup for steel M13 threaded bar

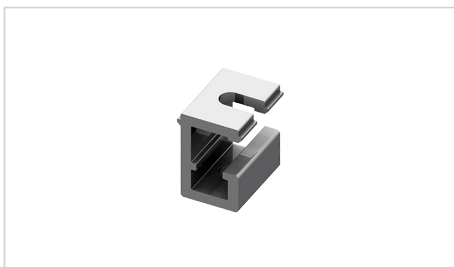

S-9000/132

Staffa per fissaggio a soffitto per sospensioni
Ceiling bracket for suspensions



S-9000/211-S-...

Cavo in acciaio con terminale a sfera
Steel cable with spherical end



S-9000/214

Tenditore automatico
Automatic lock



S-9000/215

Tenditore a vite
Screw gripper



S-9000/116-SV-HR

Staffa corta per sospensioni
Short bracket for suspensions

MODULINE M32

Moduline M32 è un prodotto adatto ad essere utilizzato in applicazioni hospitality come bar e ristoranti. Utilizzato da solo o in abbinamento a spotlights crea un ambiente accogliente e confortevole.

Moduline M32 is suitable for use in hospitality applications as bars or restaurants. Used alone or together with spotlights creates a cozy and comfortable atmosphere.

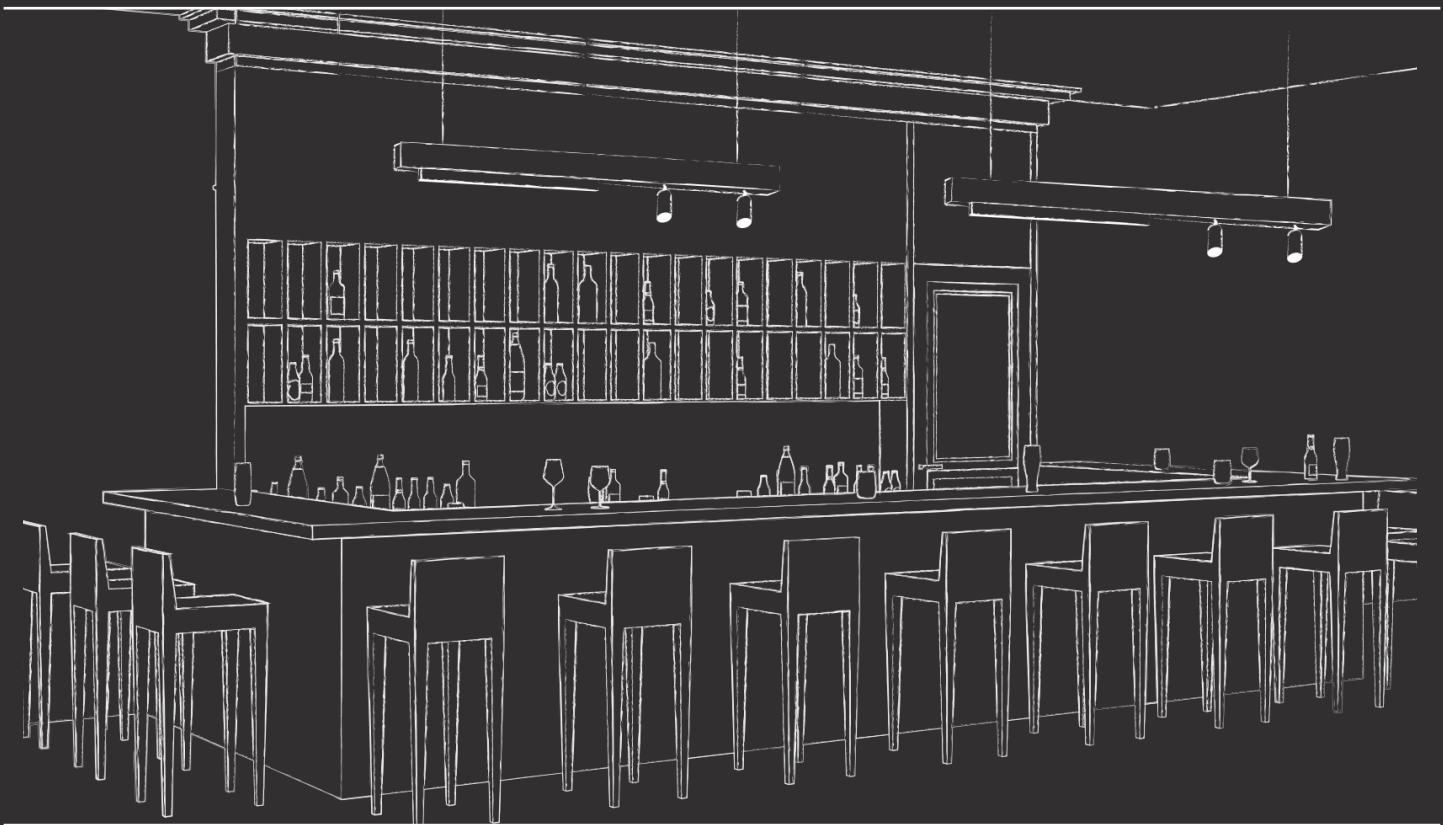

M32

Moduline M32 grazie alla sua facilità di installazione nel binario trova la sua perfetta applicazione nella luce museale, dove gli oggetti da illuminare si spostano continuamente.

Moduline M32 with its easy installation into the tracks is perfect for museum lighting where objects to be enlightened change place very often.

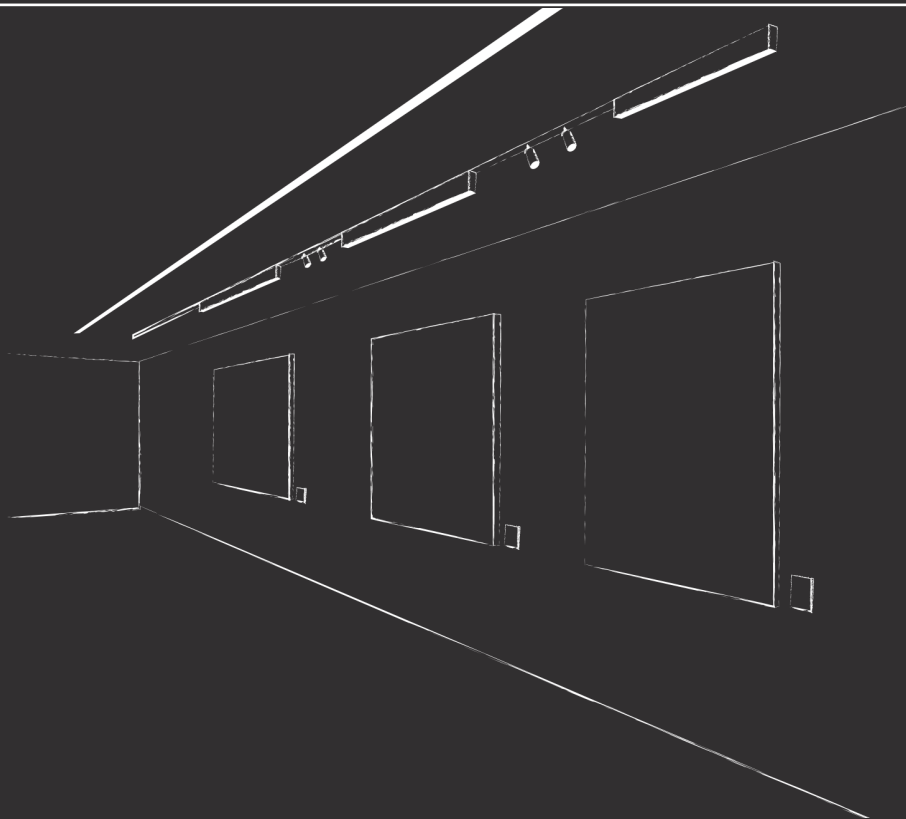

M32

COMPOSITORE CODICE

CODE COMPOSER

Codice di esempio / Code example

M32865/B5-O-2

1 2 3 4 5 6

1 - PREFISSO / PREFIX

M32

2 - MISURA / LENGTH

	OTTICHE DISPONIBILI / AVAILABLE OPTICS				
	OPALINO <i>OPAL</i>	MICROPRISMATICO <i>MICROPRISMATIC</i>	UGR	UGR CRI 90 H	WALL WASHER
585			*		
865	*	*			*
1146	*	*			*
1426				*	

3 - COLORE / COLOUR

B Nero / *Black*
RAL 9005

W Bianco / *White*
RAL 9010

4 - TEMPERATURA COLORE / COLOUR TEMPERATURE

1 3000K CRI 90 H

3 3000K CRI 95

5 3000K CRI 90

1 Solo 1426mm / *Only 1426mm*

3 Solo 585mm / *Only 585mm*

5 - SCHERMI / SCREENS

O Opalino
Opal **M** Microprismatico
Microprismatic **U** UGR **W** Wall washer

6 - DRIVER

0 ON - OFF **1** 1..10V **2** DALI SELV

ESEMPI / EXAMPLES

M32865/B5-M-2

Moduline Ontrack | L=865mm | Nero | 3000K CRI 90 | Microprismatico | DALI SELV

Moduline Ontrack | L=865mm | Black | 3000K CRI 90 | Microprismatic | DALI SELV

M321146/B5-W-1

Moduline Ontrack | L=1146mm | Nero | 3000K CRI 90 | Wall Washer | 1..10V

Moduline Ontrack | L=1146mm | Black | 3000K CRI 90 | Wall Washer | 1..10V

COMPOSIZIONE MECCANICA - OPAL / MICRO

MECHANICAL COMPOSITION - OPAL / MICRO

LUNGHEZZE DISPONIBILI (mm) / AVAILABLE LENGTHS (mm)

865 / 1146

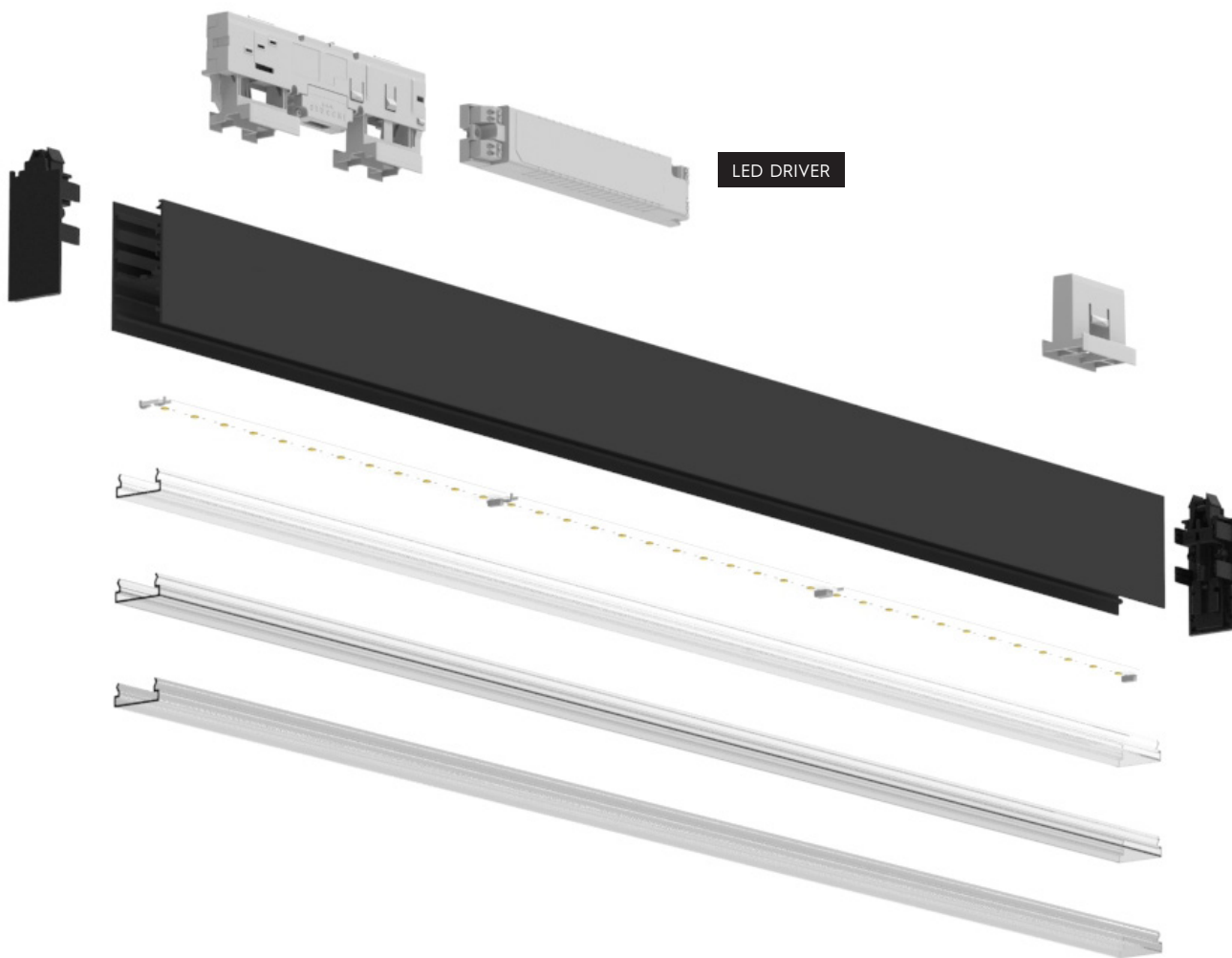

COMPOSIZIONE MECCANICA - WALL WASHER

MECHANICAL COMPOSITION - WALL WASHER

LUNGHEZZE DISPONIBILI (mm) / AVAILABLE LENGTHS (mm)

865 / 1146

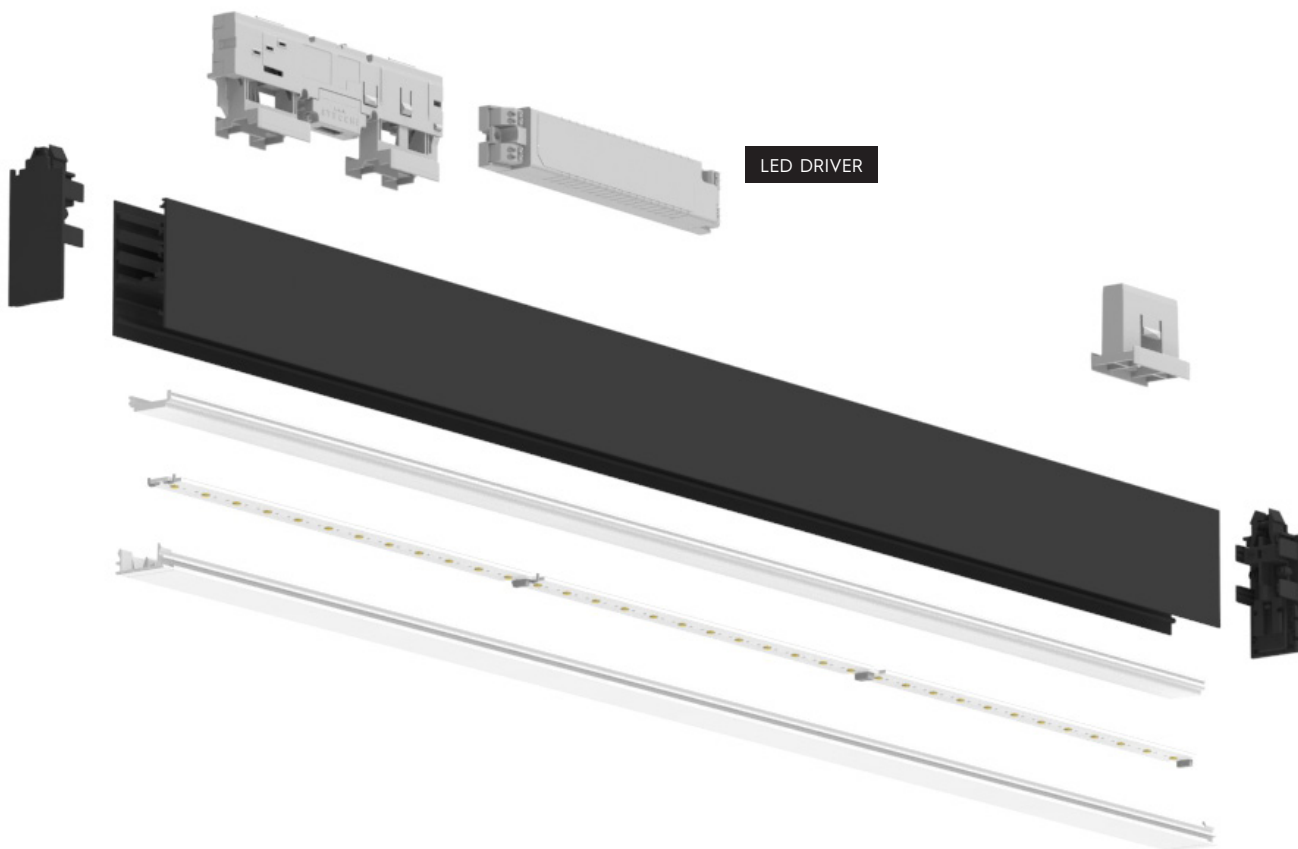

COMPOSIZIONE MECCANICA - UGR

MECHANICAL COMPOSITION - UGR

LUNGHEZZE DISPONIBILI (mm) / AVAILABLE LENGTHS (mm)

585 / 1426 (solo UGR H / Only UGR H)

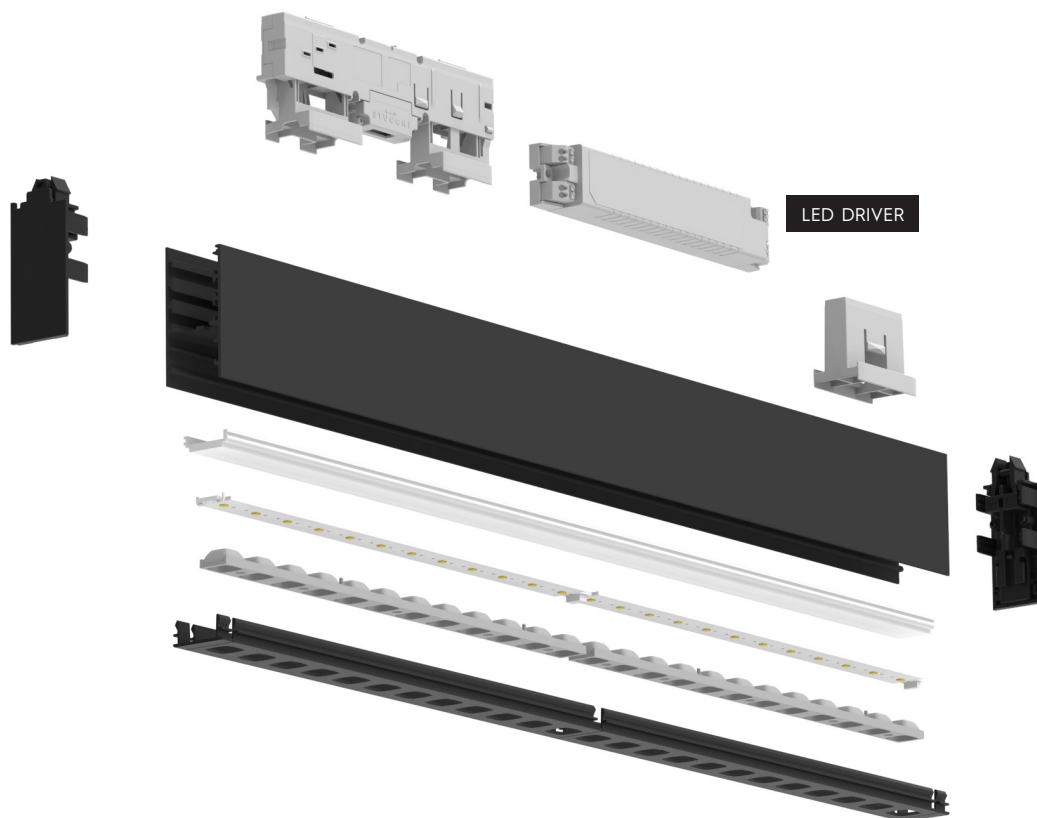

COMPONENTI COMPONENTS

***= OP / OPN

COMPONENTI COMUNI / COMMON COMPONENTS



S-9300/...LI-...
Profilo estruso
Extruded profile



9309-4/... 9309/...
Connettore di alimentazione
Power supply connector

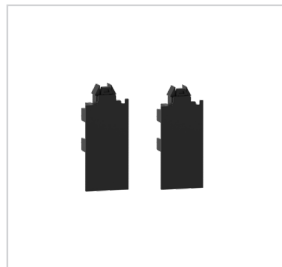

9304-L/... 9304-R/...
Tappo sinistro e Tappo destro
Left and Right end cap

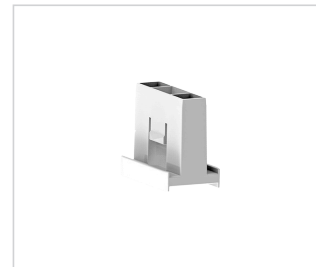

S-9309-MF/W
Supporto per momento flettente
Support for bending moment

OPAL



S-9300/*-...**
Schermo
Screen

MICRO

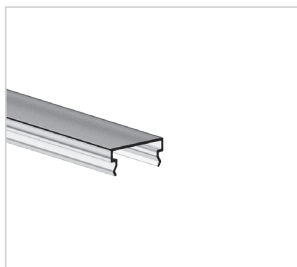

S-9300/*-3000**
Schermo
Screen



S-M22/RF
Recuperatore di flusso
Light reflector



S-LC190280L26S(C)...
Modulo 12 LED per schermi opal e micro
12 LED module for opal and micro screens

COMPONENTI

COMPONENTS

UGR

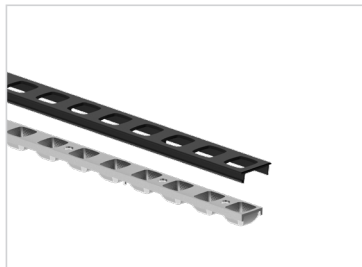

S-M22/O-UGR + S-M22/C-UGR-B
Riflettore UGR + Cover
UGR Reflector + Cover

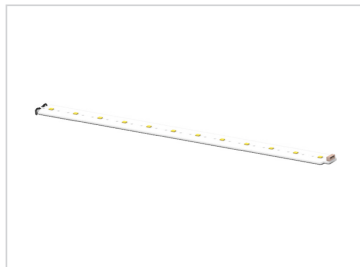

S-LC190280L12S(C)...
Modulo 12 LED per schermo UGR
12 LED module for UGR screen



S-M22/F-UGR
Pellicola isolante
Insulating film



S-PI4383-3000
Supporto LED per schermo UGR
UGR screen LED support



S-L32/T-UGR-...
Cover di chiusura estetica
Aesthetic track cover



S-L32-70/...-3000
Cover di chiusura estetica
Aesthetic track cover

COMPONENTI

COMPONENTS

WALL WASHER



S-9300/*-...**

Schermo
Screen



S-LC190280L12S(C)....

Modulo 32 LED per schermo Wall washer
32 LED module for Wall washer screen



S-P14383-3000

Supporto LED per schermo WW
WW screen LED support



S-L32/T-UGR-...

Cover di chiusura estetica
Aesthetic track cover



S-L32-70/...-3000

Cover di chiusura estetica
Aesthetic track cover

M32



Lunghezze disponibili (mm) / Available lengths (mm)

	OTTICHE DISPONIBILI / AVAILABLE OPTICS				
	OPALINO <i>OPAL</i>	MICROPRISMATICO <i>MICROPRISMATIC</i>	UGR	UGR CRI 90 H	WALL WASHER
585			*		
865	*	*			*
1146	*	*			*
1426				*	

CRI

≥90

Colori disponibili / Available colours

Nero / Black - Bianco / White

Temperatura colore / Colour temperature

3000K

Driver incluso / Driver included

Per altre misure contattare il team commerciale A.A.G. Stucchi. / For other sizes please contact A.A.G. Stucchi commercial team

Schermo Opalino
Opal screen

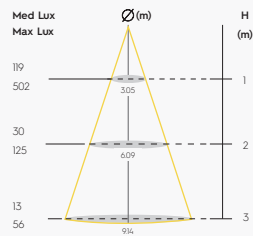
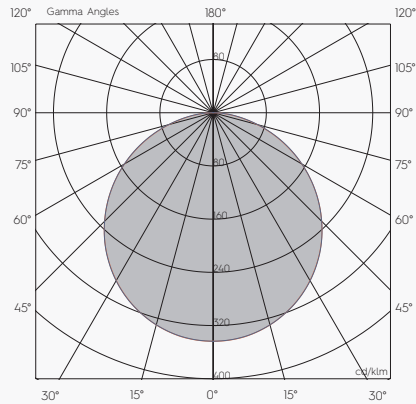

lm 1460 - W 19
lm/W 76.8 - UGR <29

Schermo Microprismatico
Microprismatic screen

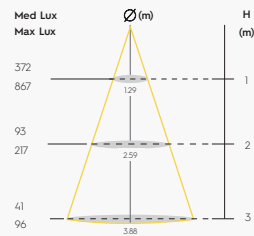
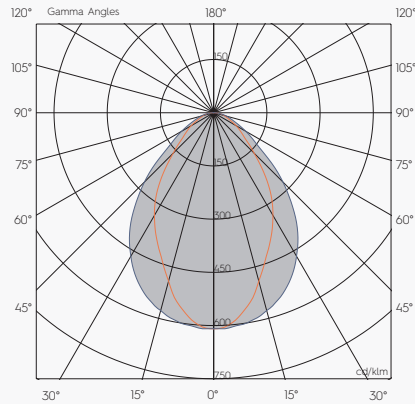

lm 1412 - W 194
lm/W 72.7 - UGR <25

Schermo Wall Washer
Wall Washer screen

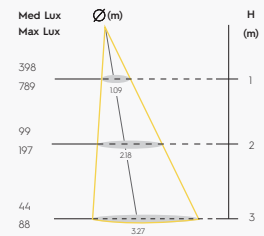
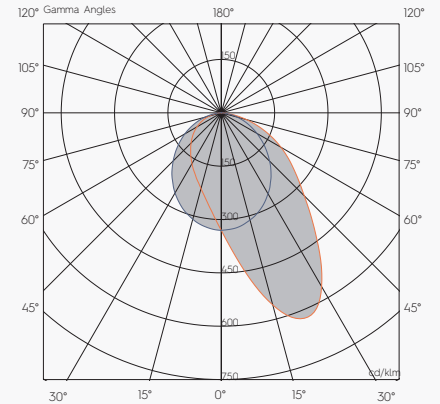

lm 2454 - W 23.5
lm/W 104.4 - UGR <29

Schermo UGR CRI 95
UGR screen CRI 95

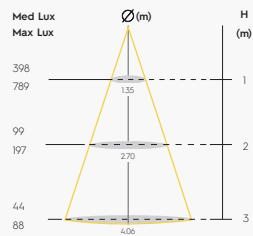
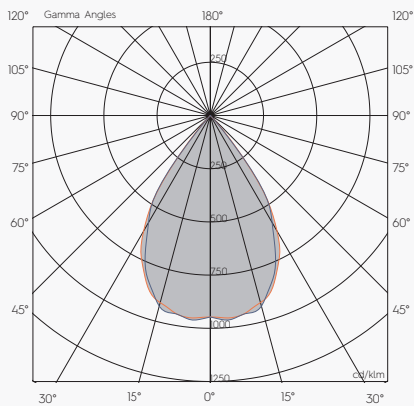

lm 1238 - W 16.6
lm/W 83.33 - UGR <17

Schermo UGR CRI 90 H
UGR screen CRI 90 H

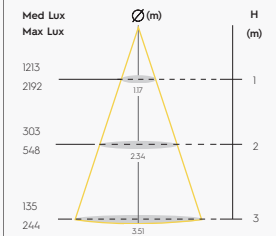
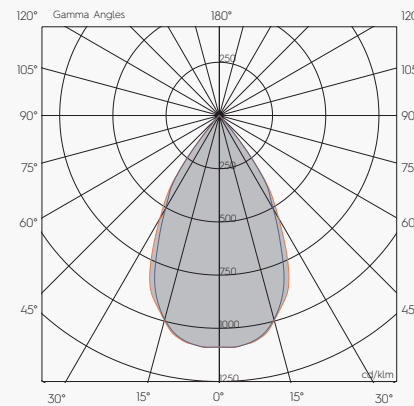

lm 2014 - W 23.2
lm/W 86.8 - UGR <19

DATI TECNICI RANGE DI PRODOTTO

PRODUCT RANGE TECHNICAL DATA

OPAL

[mm]	n°. LED Mod	[K]	I LED [mA]	FLUSSO NOMINALE [lm] <i>NOMINAL FLUX [lm]</i>	FLUSSO REALE [lm] <i>REAL FLUX [lm]</i>	POTENZA [W] <i>POWER [W]</i>	POTENZA LED [W] <i>POWER LED [W]</i>	V _F	CRI	SDCM	LIFETIME [Khr]
865	3	3000	450	2129	1461	19,4	15,9	-36	≥90	≤3	>50Khr L90B5
1146	4	3000	600	2839	1948	24,9	21,2	-36	≥90	≤3	>50Khr L90B5

MICRO

[mm]	n°. LED Mod	[K]	I LED [mA]	FLUSSO NOMINALE [lm] <i>NOMINAL FLUX [lm]</i>	FLUSSO REALE [lm] <i>REAL FLUX [lm]</i>	POTENZA [W] <i>POWER [W]</i>	POTENZA LED [W] <i>POWER LED [W]</i>	V _F	CRI	SDCM	LIFETIME [Khr]
865	3	3000	450	2129	1412	19,4	15,9	-36	≥90	≤3	>50Khr L90B5
1146	4	3000	600	2839	1883	24,9	21,2	-36	≥90	≤3	>50Khr L90B5

WALL WASHER

[mm]	n°. LED Mod	[K]	I LED [mA]	FLUSSO NOMINALE [lm] <i>NOMINAL FLUX [lm]</i>	FLUSSO REALE [lm] <i>REAL FLUX [lm]</i>	POTENZA [W] <i>POWER [W]</i>	POTENZA LED [W] <i>POWER LED [W]</i>	V _F	CRI	SDCM	LIFETIME [Khr]
865	3	3000	450	2621	2454	23,0	20,0	-45	≥90	≤3	>50Khr L90B5
1146	4	3000	600	3494	3272	30,5	26,4	-45	≥90	≤3	>50Khr L90B5

UGR<19 CRI95

[mm]	n°. LED Mod	[K]	I LED [mA]	FLUSSO NOMINALE [lm] <i>NOMINAL FLUX [lm]</i>	FLUSSO REALE [lm] <i>REAL FLUX [lm]</i>	POTENZA [W] <i>POWER [W]</i>	POTENZA LED [W] <i>POWER LED [W]</i>	V _F	CRI	SDCM	LIFETIME [Khr]
585	2	3000	500	1009	825	10,6	8,4	-17	≥95	≤3	>50Khr L90B10

UGR<19 H CRI90

[mm]	n°. LED Mod	[K]	I LED [mA]	FLUSSO NOMINALE [lm] <i>NOMINAL FLUX [lm]</i>	FLUSSO REALE [lm] <i>REAL FLUX [lm]</i>	POTENZA [W] <i>POWER [W]</i>	POTENZA LED [W] <i>POWER LED [W]</i>	V _F	CRI	SDCM	LIFETIME [Khr]
1426	2	3000	600	2291	2014	23,2	19,8	-33	≥90	≤3	>50Khr L90B10

L32

L32 il sistema di per luce lineare a 230V ispirato alle logiche dell'illuminazione a binario per la sua modularità e flessibilità. L32 garantisce una luce di qualità grazie all'utilizzo di sorgenti LED dei migliori produttori come CREE, BRIDGELUX e NICHIA.



L32

L32 is the 230V linear light system inspired by track lighting logics in terms of flexibility and modularity. L32 provides a high quality light as it is produced with the best LED sources on the market as CREE, BRIDGELUX and NICHIA.



L32

COMPOSITORE CODICE

CODE COMPOSER

Codice di esempio / Code Example

L32S330/BG5-O-1



1 - PREFISSO / PREFIX

L32

2 - MONTAGGIO / MOUNTING

S Modulo singolo / Single module **F** Fila continua / In row use

3 - LUNGHEZZE DISPONIBILI (L) / AVAILABLE LENGTHS (L)

2 S → 566mm

3 S → 846mm
F → 841mm

4 S → 1126mm
F → 1121mm

5 S → 1406mm
F → 1401mm

MONOEMISSIONE / MONOEMISSION

MONTAGGIO / MOUNTING	LUNGHEZZA / LENGTH (L)	OTTICHE DISPONIBILI / AVAILABLE OPTICS			
		OPAL	MICRO	WALL WASHER	UGR UGR HO
S	2				*
S/F	3	*	*	*	
S/F	4	*	*	*	
S	5				*

BIEMISSIONE / BIEMISSION

MONTAGGIO / MOUNTING	LUNGHEZZA / LENGTH (L)	OTTICHE DISPONIBILI / AVAILABLE OPTICS			
		OPAL	MICRO	WALL WASHER	UGR UGR HO
S	3	*	*	*	
S/F	4	*	*	*	
S	5				*

4 - N° SCHEDE LED LUCE DIRETTA / N° DIRECT LIGHT LED MODULE

(L) 2 → **2** (L) 3 → **3** (L) 4 → **4** (L) 5 → **2**

5 - N° SCHEDE LED LUCE INDIRECTA / N° INDIRECT LIGHT LED MODULE

Monoemissione **0** Biemissione **2** (L) 3 → **2** (L) 4 → **3** (L) 5 → **4**
Monoemission *Biemission*

6 - COLORE / COLOUR

BG Nero gofrato / *Black embossed* **W2** Bianco gofrato / *White embossed*
 RAL 9005 RAL 9016

7 - TEMPERATURA COLORE / COLOUR TEMPERATURE

1 3000K CRI 90 H **3** 3000K CRI 95 **5** 3000K CRI 90

LUCE / LIGHT	LUCE DOWN / DOWN LIGHT				
	OPAL	MICRO	WALL WASHER	UGR	UGR HO
1					*
3				*	
5	*	*	*		

Luce UP: Opal 3000 CRI 90
 Up light: Opal 3000 CRI 90

8 - SCHERMI / SCREENS

O Opalino **M** Microprismatic **W** Wall washer **U** UGR / UGR HO
Opal *Microprismatic*

Versioni biemissione: luce up Opal / *Biemission versions: Opal up light*

9 - DRIVER

0 ON - OFF **1** 0...10V **2** DALI SELV **3** PUSH

L32

Plafone/Sospensione monoemissione

Ceiling/Suspension monoemission

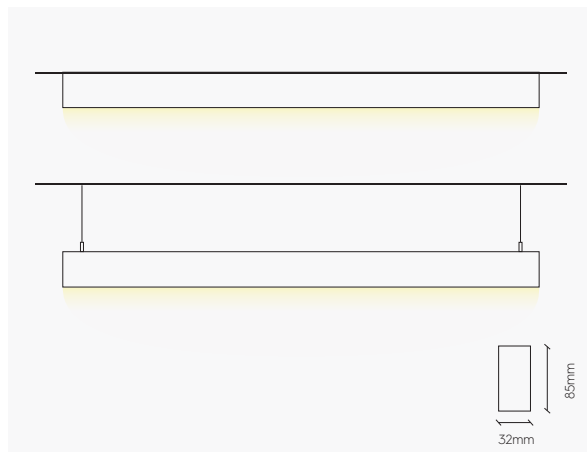

Lunghezze disponibili (mm) / Available lengths (mm)

MONTAGGIO / MOUNTING	LUNGHEZZA / LENGTH	OTTICHE DISPONIBILI / AVAILABLE OPTICS				
		OPAL	MICRO	WALL WASHER	UGR	UGR HO
S	2				*	
S/F	3	*	*	*		
S/F	4	*	*	*		
S	5					*

CRI

≥90
≥95

Colori disponibili / Available colours

Nero gofrato / Black embossed
Bianco gofrato / White embossed

Temperatura colore / Colour temperature

3000K

Driver incluso / Driver included

Per altre misure contattare il team commerciale A.A.G. Stucchi. / For other sizes please contact A.A.G. Stucchi commercial team

Schermo Opalino
Opal screen

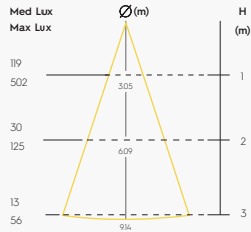
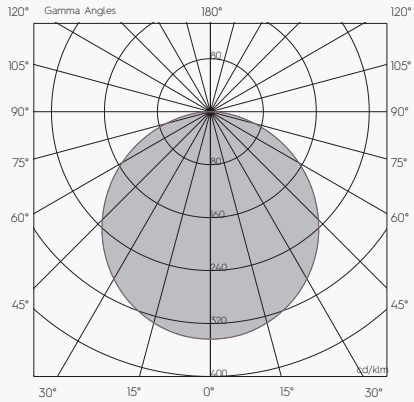

lm 1461 - W 19,4
lm/W 75,3 - UGR <29

Schermo Microprismatic
Microprismatic screen

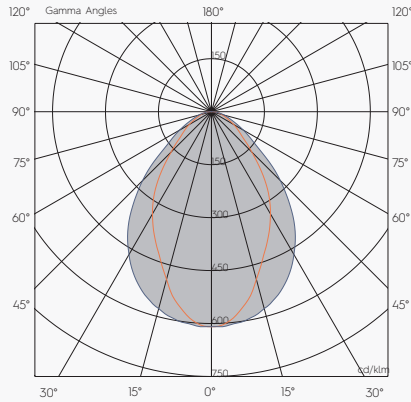

lm 1410 - W 19,4
lm/W 72,7 - UGR <25

Schermo Wall Washer
Wall Washer screen

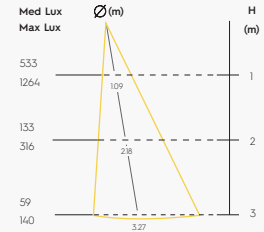
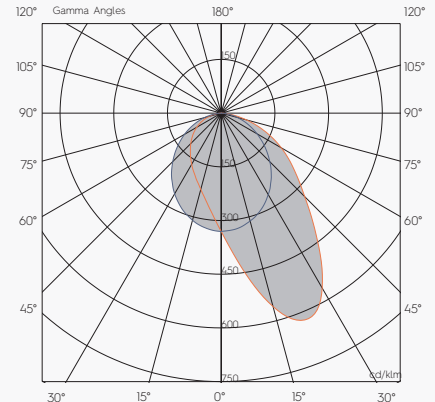

lm 2454 - W 23,5
lm/W 104,4 - UGR <29

Schermo UGR CRI 95
UGR screen CRI 95

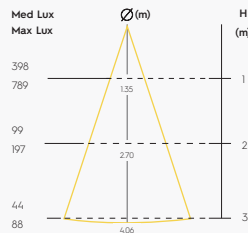
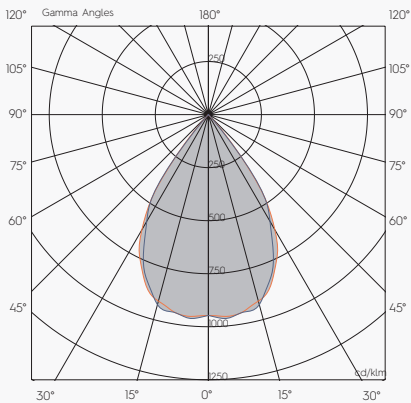

lm 825 - W 10,6
lm/W 77,8 - UGR <17

Schermo UGR CRI 90 H
UGR screen CRI 90 H

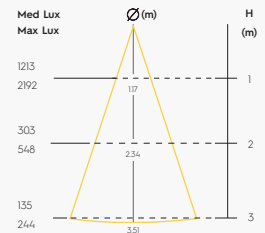
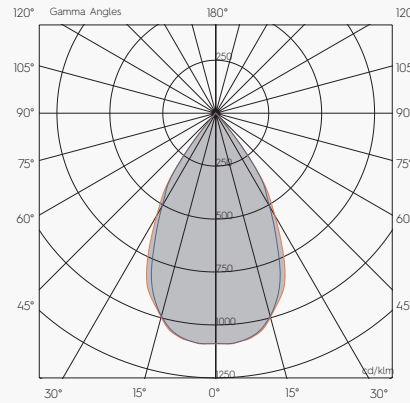

lm 2014 - W 23,2
lm/W 86,8 - UGR <19

DATI TECNICI RANGE DI PRODOTTO

PRODUCT RANGE TECHNICAL DATA

Modulo singolo / Fila continua MONOEMISSIONE / *MONOEMISSION Single module / in row use*

OPAL

[mm]	n°. LED Mod	[K]	I LED [mA]	FLUSSO NOMINALE [lm] <i>NOMINAL FLUX [lm]</i>	FLUSSO REALE [lm] <i>REAL FLUX [lm]</i>	POTENZA [W] <i>POWER [W]</i>	POTENZA LED [W] <i>POWER LED [W]</i>	V _F	CRI	SDCM	LIFETIME [Khr]
846/841	3	3000	450	2129,4	1461	19,4	15,9	-36	≥90	≤3	>50Khr L90B5
1126/1121	4	3000	600	2839,2	1948	24,9	21,2	-36	≥90	≤3	>50Khr L90B5

MICRO

[mm]	n°. LED Mod	[K]	I LED [mA]	FLUSSO NOMINALE [lm] <i>NOMINAL FLUX [lm]</i>	FLUSSO REALE [lm] <i>REAL FLUX [lm]</i>	POTENZA [W] <i>POWER [W]</i>	POTENZA LED [W] <i>POWER LED [W]</i>	V _F	CRI	SDCM	LIFETIME [Khr]
846/841	3	3000	450	2129,4	1410	19,4	15,9	-36	≥90	≤3	>50Khr L90B5
1126/1121	4	3000	600	2839,2	1880	24,9	21,2	-36	≥90	≤3	>50Khr L90B5

WALL WASHER

[mm]	n°. LED Mod	[K]	I LED [mA]	FLUSSO NOMINALE [lm] <i>NOMINAL FLUX [lm]</i>	FLUSSO REALE [lm] <i>REAL FLUX [lm]</i>	POTENZA [W] <i>POWER [W]</i>	POTENZA LED [W] <i>POWER LED [W]</i>	V _F	CRI	SDCM	LIFETIME [Khr]
846/841	3	3000	450	2620,8	2454	23,5	19,8	-45	≥90	≤3	>50Khr L90B5
1126/1121	4	3000	600	3494,4	3272	30,5	26,4	-45	≥90	≤3	>50Khr L90B5

DATI TECNICI RANGE DI PRODOTTO

PRODUCT RANGE TECHNICAL DATA

Modulo singolo / Fila continua MONOEMISSIONE / *MONOEMISSION Single module / in row use*

URG<19 CRI95

[mm]	n°. LED Mod	[K]	I LED [mA]	FLUSSO NOMINALE [lm] <i>NOMINAL FLUX [lm]</i>	FLUSSO REALE [lm] <i>REAL FLUX [lm]</i>	POTENZA [W] <i>POWER [W]</i>	POTENZA LED [W] <i>POWER LED [W]</i>	V _F	CRI	SDCM	LIFETIME [Khr]
566*	2	3000	500	1008,7	825	10,6	8,4	-18	≥95	≤3	>50Khr L90B10

URG<19 CRI90 H

[mm]	n°. LED Mod	[K]	I LED [mA]	FLUSSO NOMINALE [lm] <i>NOMINAL FLUX [lm]</i>	FLUSSO REALE [lm] <i>REAL FLUX [lm]</i>	POTENZA [W] <i>POWER [W]</i>	POTENZA LED [W] <i>POWER LED [W]</i>	V _F	CRI	SDCM	LIFETIME [Khr]
1406*	2	3000	600	2291,3	2014	23,2	19,8	-33	≥90	≤3	>50Khr L90B5

*Non disponibile in fila continua / *In row use version not available*

L32

Sospensione bi-emissione con accensione separata
Suspension bi-emission with separate switch on

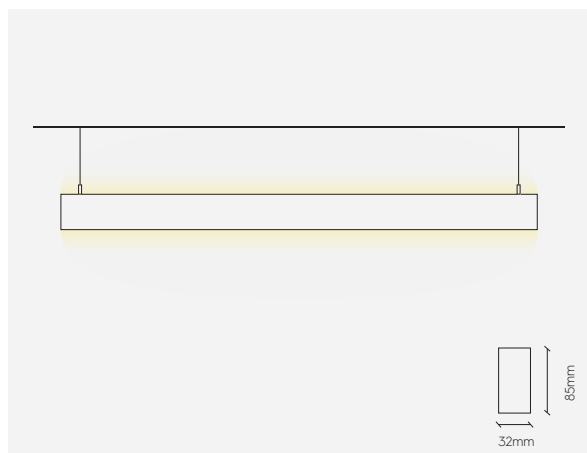

220/240V

IP40

RG0
at 1,2m



Lunghezze disponibili (mm) / Available lengths (mm)

MONTAGGIO / MOUNTING	LUNGHEZZA / LENGTH	OTTICHE DISPONIBILI / AVAILABLE OPTICS			
		OPAL	MICRO	WALL WASHER	UGR HO
S	3	*	*	*	
S/F	4	*	*	*	
S	5				*

CRI
≥90

Colori disponibili / Available colours
Nero gofrato / Black embossed
Bianco gofrato / White embossed

Temperatura colore / Colour temperature
3000K

Driver incluso / Driver included

Per altre misure contattare il team commerciale A.A.G. Stucchi. / For other sizes please contact A.A.G. Stucchi commercial team

Schermo Opalino
Opal screen

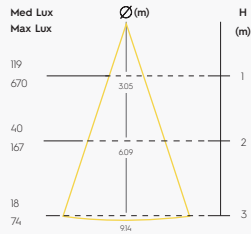
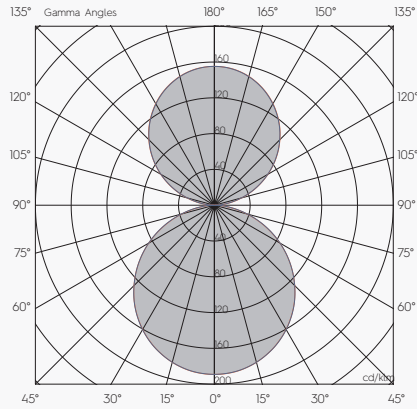

lm 3541 - W 46,9
lm/W 75,5 - UGR <28

Schermo Microprismatico
Microprismatic screen

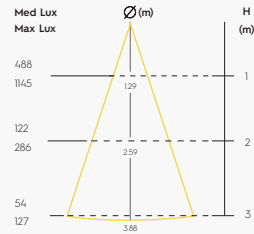
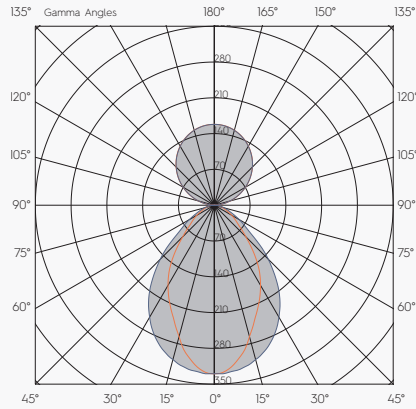

lm 3473 - W 46,9
lm/W 74,0 - UGR <25

Schermo Wall Washer
Wall Washer screen

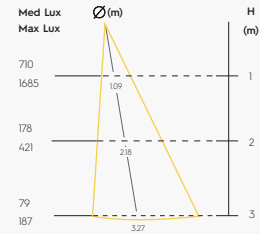
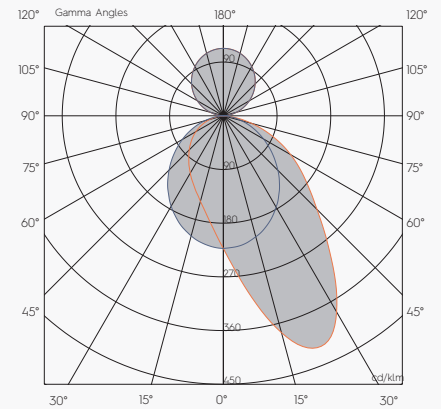

lm 4865 - W 52,5
lm/W 92,6 - UGR <28

Schermo UGR CRI 90 H
UGR screen CRI 90 H

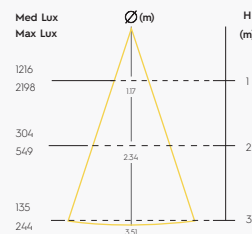
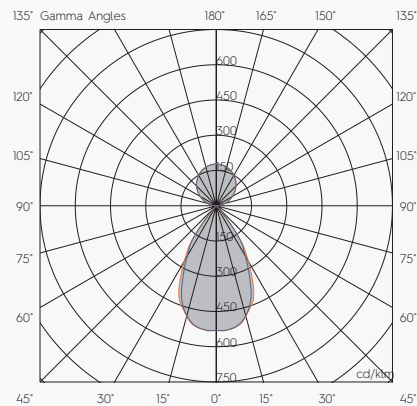

lm 4137 - W 52,2
lm/W 79,2 - UGR <16

DATI TECNICI RANGE DI PRODOTTO

PRODUCT RANGE TECHNICAL DATA

Modulo singolo / Fila continua BIEMISSIONE / BIEMISSION Single module / in row use

OPAL

[mm]	n°. LED Mod	[K]	I LED [mA]	FLUSSO NOMINALE [lm] NOMINAL FLUX [lm]	FLUSSO REALE [lm] REAL FLUX [lm]	POTENZA [W] POWER [W]	POTENZA LED [W] POWER LED [W]	V _F	CRI	SDCM	LIFETIME [Khr]
846*	3+2	3000	450+350	2129,4+1638	1461+1062	34,1	28,5	-36	≥90	≤3	>50Khr L90B5
1121/1126	4+3	3000	600+525	2839,2+2457	1948+1593	46,9	40,1	-36	≥90	≤3	>50Khr L90B5

MICRO

[mm]	n°. LED Mod	[K]	I LED [mA]	FLUSSO NOMINALE [lm] NOMINAL FLUX [lm]	FLUSSO REALE [lm] REAL FLUX [lm]	POTENZA [W] POWER [W]	POTENZA LED [W] POWER LED [W]	V _F	CRI	SDCM	LIFETIME [Khr]
846*	3+2	3000	450+350	2129,4+1638	1410+1062	34,1	28,5	-36	≥90	≤3	>50Khr L90B5
1121/1126	4+3	3000	600+525	2839,2+2457	1880+1593	46,9	40,1	-36	≥90	≤3	>50Khr L90B5

*Non disponibile in fila continua / In row use version not available

DATI TECNICI RANGE DI PRODOTTO

PRODUCT RANGE TECHNICAL DATA

Modulo singolo / Fila continua BIEMISSIONE / BIEMISSION Single module / in row use

WALL WASHER

[mm]	n°. LED Mod	[K]	I LED [mA]	FLUSSO NOMINALE [lm] NOMINAL FLUX [lm]	FLUSSO REALE [lm] REAL FLUX [lm]	POTENZA [W] POWER [W]	POTENZA LED [W] POWER LED [W]	V _f	CRI	SDCM	LIFETIME [Khr]
846*	3+2	3000	450+350	2626,8+1638	2454+1062	38,2	32,4	-45 + -36	≥90	≤3	>50Khr L90B5
1121/1126	4+3	3000	600+525	3494,4+2457	3272+1593	52,5	45,3	-45 + -36	≥90	≤3	>50Khr L90B5

UGR H

[mm]	n°. LED Mod	[K]	I LED [mA]	FLUSSO NOMINALE [lm] NOMINAL FLUX [lm]	FLUSSO REALE [lm] REAL FLUX [lm]	POTENZA [W] POWER [W]	POTENZA LED [W] POWER LED [W]	V _f	CRI	SDCM	LIFETIME [Khr]
1406*	3+2	3000	600+700	2291,3+3276	2014+2123	52,2	45	-33 + -36	≥90	≤3	>50Khr L90B10

*Non disponibile in fila continua / In row use version not available

ACCESSORI

ACCESSORIES

ACCESSORI / ACCESSORIES



L32-04/...-05

Kit tappi di chiusura per sospensione/soffitto
End caps kit for suspended/ceiling fixing

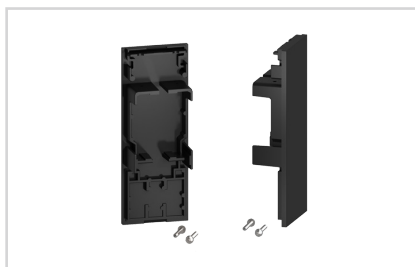

L32-04/...-01

Kit tappi di chiusura per fissaggio a parete
End caps kit for wall fixing

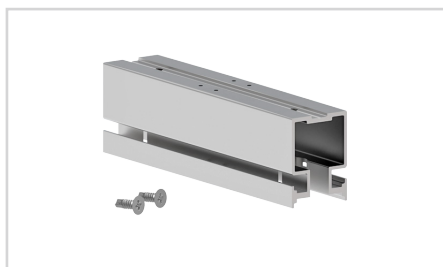

L32-01/00-01

Giunto passante
Jointing connector



L32-S-00/00-05

Staffa per giunzioni in fila continua
Bracket for "in row" use junction



L32-70/...-30

Cover di chiusura estetica
Aesthetic track cover

... W2 = Bianco gofrato / *White embossed*
... BG = Nero gofrato / *Black embossed*

SET DI FISSAGGIO / FIXING SET



SET-S-3

Set per fissaggio a sospensione
Suspension set

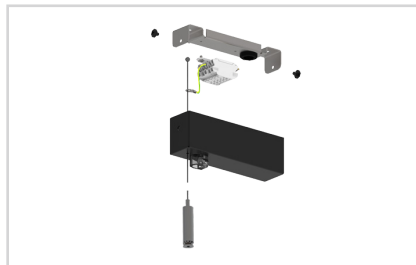

SET-RS-...-3

Set per fissaggio a soffitto
Set for ceiling mounting



KIT-SP

Kit staffe per fissaggio a parete
Brackets kit for wall mounting

GIUNTI / JOINTS

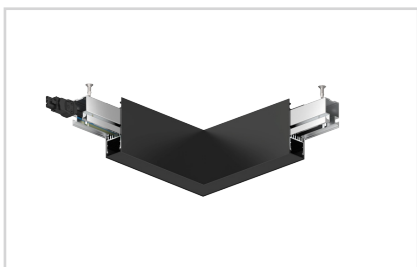

L32-11/...-01

Giunto a L monoemissione (ON-OFF)
Single-emission (ON-OFF) L-joint

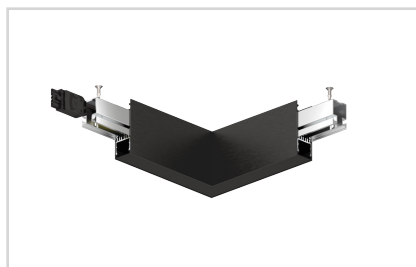

L32-11/...-02

Giunto a L*
*L-joint**

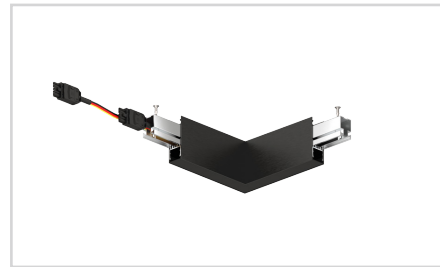

L32-11/...-03

Giunto a L biemissione (0..10V)
Bi-emission L-joint (0..10V)

*Biemissione (ON-OFF, DALI, PUSH) - Monoemissione (0..10V, DALI, PUSH)

*Bi-emission (ON-OFF, DALI, PUSH) - Monoemission (0..10V), DALI, PUSH)

L32 - L shape

L32 nelle sue configurazioni ad L è pensato per creare layout di luce dinamici che si adattano ad ogni ambiente. La possibilità di utilizzo in fila continua insieme ai moduli lineari della stessa gamma permette di avere la massima libertà nei progetti di illuminazione.

L32 L shape is meant to create dynamic light layout that fit any application. The "in row" modules can be used together with the linear ones thus giving maximum freedom to lighting projects.

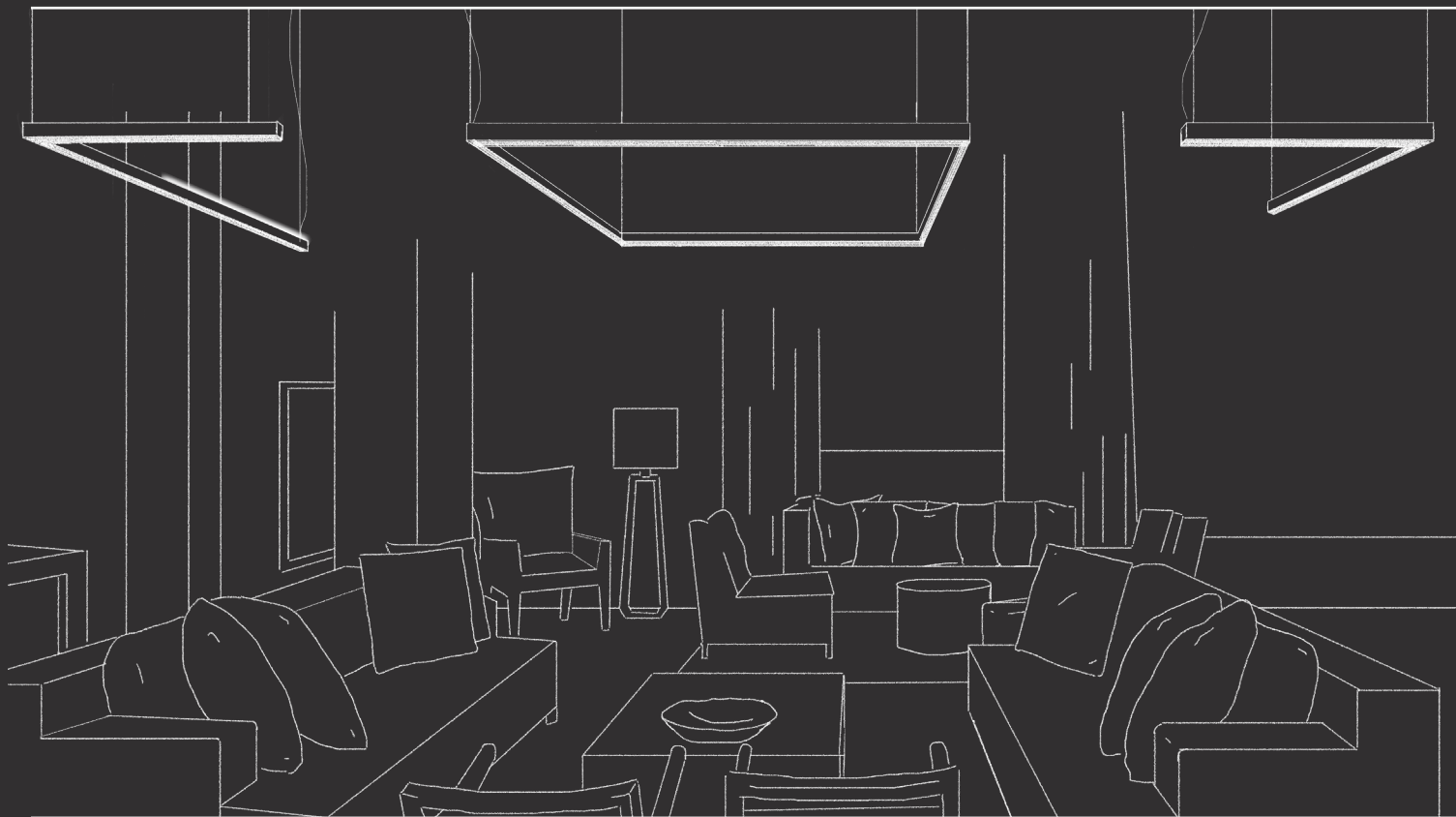

L32

Informazioni tecniche per la composizione in fila continua

Technical info for "in row" composition

Per riconoscere la direzione dell'angolo, tracciare una linea immaginaria dal vertice del lato più corto verso il vertice del lato più lungo.
 To recognize the angle direction, draw an imaginary line from bottom of the shortest side towards the top the longer one.

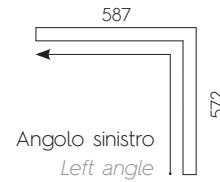
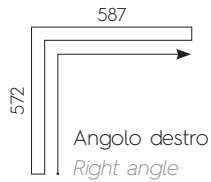

L32F...
 (x4)

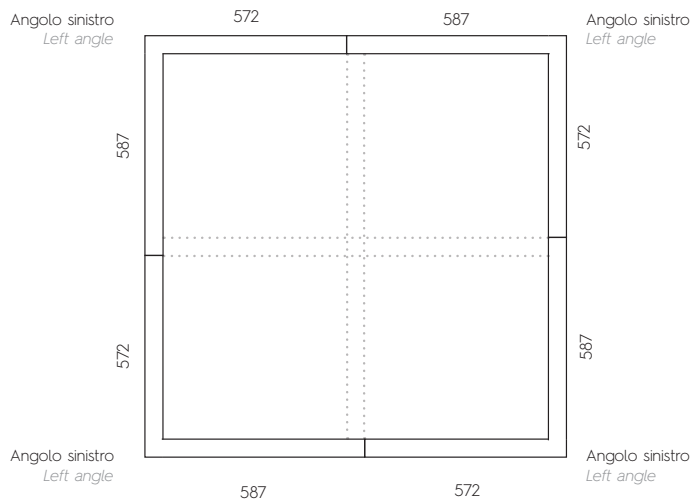

 Giunture non simmetriche
 Non-symmetric junction

L32FD + L32FS / L32FS + L32FT
 (x2) (x2)

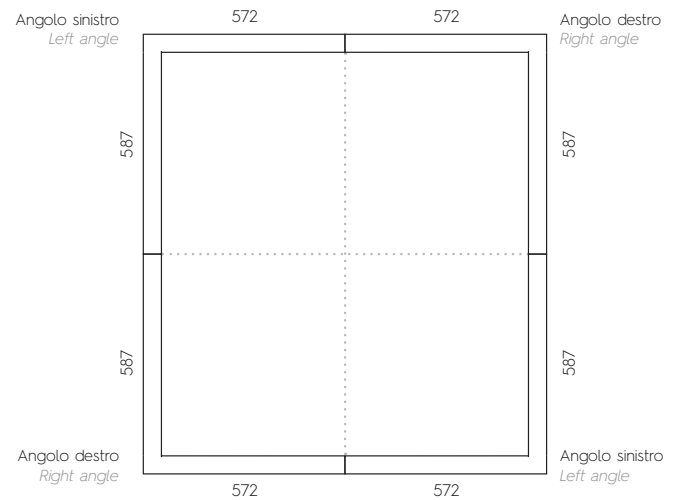

 Giunture simmetriche
 Symmetric junction

COMPOSITORE CODICE

CODE COMPOSER

Codice di esempio / Code Example

L32SD440/BG5-O-1

↓ ↓ ↓ ↓ ↓ ↓ ↓ ↓ ↓ ↓
1 2 3 4 5 6 7 8 9 10

1 - PREFISSO / PREFIX

L32

2 - MONTAGGIO / MOUNTING

S Modulo singolo / Single module

F Filà continua / In row use

3 - TIPOLOGIA DI MONTAGGIO / MOUNTING TYPE

	S	F Monoemissione Monoemission	F Biemissione Biemission
D Angolo destro Right angle	*	*	Solo per apparecchi Only for lighting fixtures
S Angolo sinistro Left angle	*	*	L32F... PUSH / DALI
E Angolo destro Right angle			Solo per apparecchi Only for lighting fixtures
T Angolo sinistro Left angle			L32F... ON-OFF / 0..10V

4 - LUNGHEZZE DISPONIBILI / AVAILABLE LENGTHS

4

S → 574x589mm

F → 572x587mm

5 - SCHEDE LED LUCE DIRETTA / *DIRECT LIGHT LED MODULE*

4

6 - SCHEDE LED LUCE INDIRETTA / *INDIRECT LIGHT LED MODULE*

0

7 - COLORE / *COLOUR*

BG Nero gofrato / *Black embossed*
RAL 9005

W2 Bianco gofrato / *White embossed*
RAL 9016

8 - TEMPERATURA COLORE / *COLOUR TEMPERATURE*

5 3000K CRI 90

9 - SCHERMI / *SCREENS*

O Opalino
Opal

M Microprismatico
Microprismatic

10 - DRIVER

0 ON - OFF

1 0..10V

2 DALI SELV

3 PUSH

L32 - L SHAPE

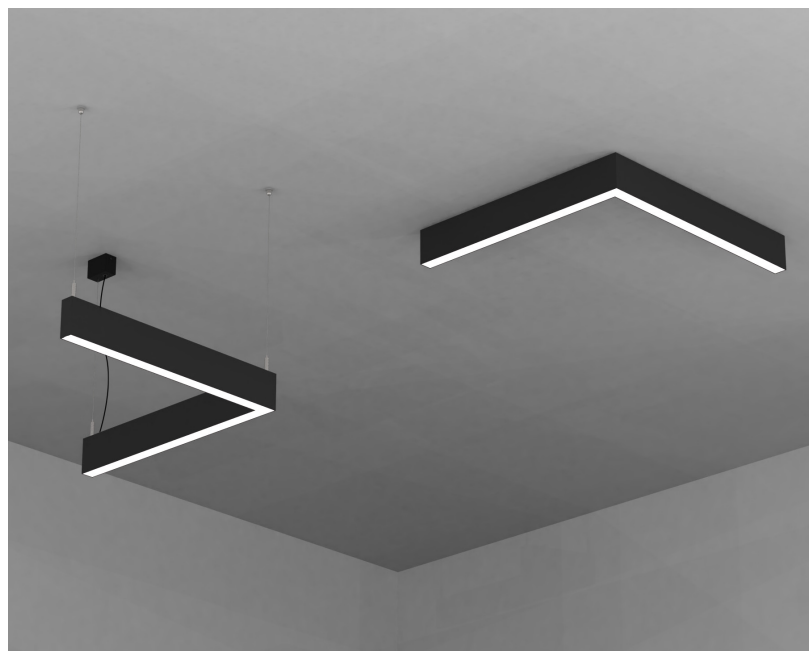
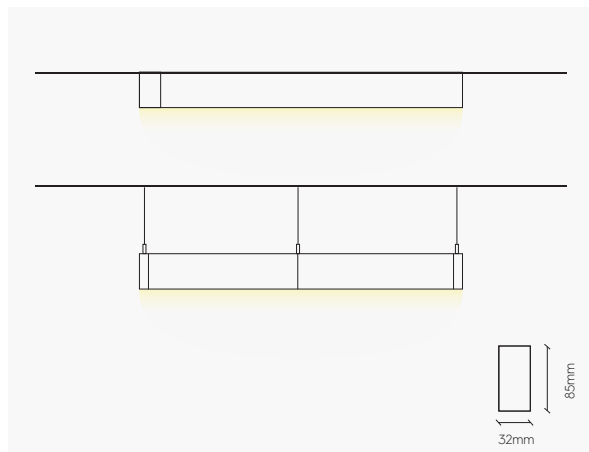

220/240V

IP40

O/M

RG0
at 1,2m



Lunghezze disponibili (mm) / Available lengths (mm)

S → 574x589mm

F → 572x587mm

CRI

≥90

Colori disponibili / Available colours

Nero gofrato / Black embossed

Bianco gofrato / White embossed

Temperatura colore / Colour temperature

3000K

Driver incluso / Driver included

ACCESSORI

ACCESSORIES

ACCESSORI / ACCESSORIES

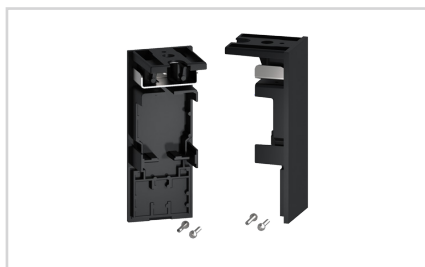

L32-04/...-05

Kit tappi di chiusura per sospensione/soffitto
End caps kit for suspended/ceiling fixing

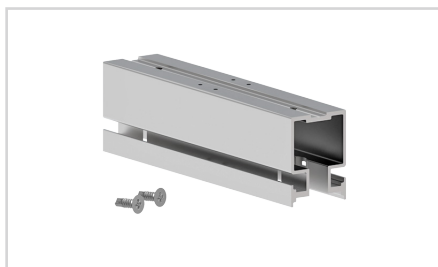

L32-01/00-01

Giunto passante
Joining connector



L32-S-00/00-05

Staffa per giunzioni in fila continua
Bracket for "in row" use junction

SET DI FISSAGGIO / FIXING SET



SET-S-3

Set per fissaggio a sospensione
Suspension set

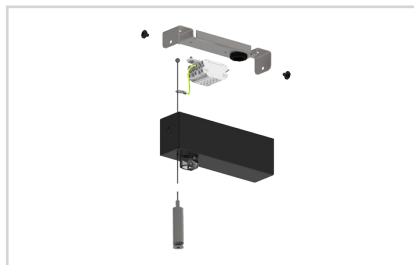

SET-RS-...-3

Set per fissaggio a soffitto
Set for ceiling mounting

... W2 = Bianco gofrato / *White embossed*
... BG = Nero gofrato / *Black embossed*

LEGENDA SIMBOLI / SYMBOLS LEGEND



Rischio fotobiologico e distanza di soglia
Photobiological risk and treshold distance



Rischio fotobiologico basso / *Photobiological low risk*



Classe energetica riferita a tutti i prodotti forniti con moduli led integrati e non sostituibili.
Energy Efficiency class referred to all products supplied with integrated LED module, not replaceable.

Secondo il regolamento N847/2012. / *In compliance with Directive N847/2012*



Apparecchio per collegamento ad impianti a basso voltaggio. / *Anti-shock protection depends on safety low-power voltage.*



Il prodotto risponde ai requisiti essenziali di sicurezza dell'Unione Europea. / *Product complies with essential safety requirement of European Union market.*

L'azienda declina ogni responsabilità per eventuali errori di stampa. I dati tecnici relativi ai prodotti possono essere aggiornati in qualsiasi momento.
The company declines any misprinting responsibility. Technical data can be updated at any time.

A.A.G. STUCCHI s.r.l. u.s.
Via IV Novembre 30/32, 23854
Olginate (LC) - ITALY
Ph. +39-0341-653111
Fax +39-0341-653250
info@aagstucchi.it

A.A.G. STUCCHI NORTH AMERICA, INC.
5080 North Royal Atlanta Drive
Tucker, GA 30084 - USA
Ph. +1-404-806-5399
northamerica@aagstucchi.com

A.A.G. STUCCHI ASIA PACIFIC LTD.
Regional office
Room 01, 11/fl., New Treasure Centre
N° 10 Ng Fong Street, Kowloon - HONG KONG
Ph. +852-2578-8988
Fax +852-2571-5039
hongkong@aagstucchi.hk

A.A.G. STUCCHI SHANGHAI LTD.
Rm 3007, N°738, Chang Yang Rd
YangPu area, 200082 - SHANGHAI
Ph. +86-21-51816507
Fax +86-21-51816508
east@aagstucchi.hk

aagstucchi.it



Aggiornamento Febbraio 2023

February 2023 update

