



SERIES 1820 - SINGLE AND DOUBLE-POLE TOGGLE SWITCHES

TO 6 (4) A 250 V AC





PRODUCT FEATURES

- 100 million times proven switching principle
- Long life endurance with 50 000 mechanical switching cycles
- Excellent actuating characteristic
- Fastening with nut M12

ON REQUEST

- Other colors
- Other switching functions
- Other terminal variants
- Cable assembly

Mechanical life endurance	5E4
Contact resistance (new condition)	< 100 mOhm (1 A 12 V DC)
Insulation resistance (new condition)	> 100 MOhm (500 V DC)
Proof tracking	250 PTI
Protection type	IP 40
Ambient temperature	terminal side -20 °C ... +100 °C actuating side -20 °C ... +55 °C
Flammability	UL 94 V-2
Glow wire test temperature	850 °C
Material actuator housing terminals	PA PA glass fiber-reinforced / PA silver plated
Plug force of the terminals	≤ 80 N
Approval marks	 /  / 
Suitable for appliances of protection class II	

ROCKER SWITCHES

PUSHBUTTON SWITCHES

TOGGLE SWITCHES

SLIDE SWITCHES

ROTARY SWITCHES

FOOT SWITCHES

TACT AND KEY SWITCHES

SNAP-ACTION SWITCHES

MICRO-SIGNAL SWITCHES

SENSORS

ECO

PUSH IN DRIVE



SERIES 1820 - SINGLE AND DOUBLE-POLE TOGGLE SWITCHES

TO 6 (4) A 250 V AC

 single-pole	Actuator color / printing	Housing color	6 (4) A 250 V AC 5E4	6 (2) A 250 V AC 1E4	6 A 250 V AC 1/2 HP	6 A 125 V AC 1/4 HP	Terminal type	Terminal description	Contact distance (mm)	Contact material	Miscellaneous	Stock version
	ON / OFF switch (SPST)											
1821.1101			<input type="radio"/>	<input type="radio"/>	<input type="radio"/>	<input type="radio"/>		4.8	≥ 3	Ag		<input type="radio"/>
1821.6101			<input type="radio"/>	<input type="radio"/>	<input type="radio"/>	<input type="radio"/>			≥ 3	Ag		<input type="radio"/>
Changeover switch (SPDT)												
1823.1101			<input type="radio"/>	<input type="radio"/>	<input type="radio"/>	<input type="radio"/>		4.8	≥ 3	Ag		<input type="radio"/>
1823.6101			<input type="radio"/>	<input type="radio"/>	<input type="radio"/>	<input type="radio"/>			≥ 3	Ag		<input type="radio"/>
Changeover switch with OFF position in the center (SPDT - Center OFF)												
1828.1101			<input type="radio"/>	<input type="radio"/>	<input type="radio"/>	<input type="radio"/>		4.8	< 3	Ag		<input type="radio"/>
1828.1201			<input type="radio"/>	<input type="radio"/>	<input type="radio"/>	<input type="radio"/>		4.8	< 3	Ag	momentary function one side	<input type="radio"/>
1828.1301			<input type="radio"/>	<input type="radio"/>	<input type="radio"/>	<input type="radio"/>		4.8	< 3	Ag	momentary function both sides	<input type="radio"/>

 double-pole	Actuator color / printing	Housing color	6 (4) A 250 V AC 5E4	6 (2) A 250 V AC 1E4	6 A 250 V AC 1/2 HP	6 A 125 V AC 1/4 HP	Terminal type	Terminal description	Contact distance (mm)	Contact material	Miscellaneous	Stock version
	ON / OFF switch (DPST)											
1822.1101			<input type="radio"/>	<input type="radio"/>	<input type="radio"/>	<input type="radio"/>		4.8	≥ 3	Ag		<input type="radio"/>
Changeover switch (DPDT)												
1824.1101			<input type="radio"/>	<input type="radio"/>	<input type="radio"/>	<input type="radio"/>		4.8	≥ 3	Ag		<input type="radio"/>
Changeover switch with OFF position in the center (DPDT - Center OFF)												
1829.1101			<input type="radio"/>	<input type="radio"/>	<input type="radio"/>	<input type="radio"/>		4.8	< 3	Ag		<input type="radio"/>
1829.1301			<input type="radio"/>	<input type="radio"/>	<input type="radio"/>	<input type="radio"/>		4.8	< 3	Ag	momentary function both sides	<input type="radio"/>

ROCKER SWITCHES

PUSHBUTTON SWITCHES

TOGGLE SWITCHES

SLIDE SWITCHES

ROTARY SWITCHES

FOOT SWITCHES

TACT AND KEY SWITCHES

SNAP-ACTION SWITCHES

MICRO-SIGNAL SWITCHES

SENSORS

ECO

PUSH/DRIVE



SERIES 1820 - SINGLE AND DOUBLE-POLE TOGGLE SWITCHES

TO 6 (4) A 250 V AC



Basic types 1821, 1823 and 1828 single-pole

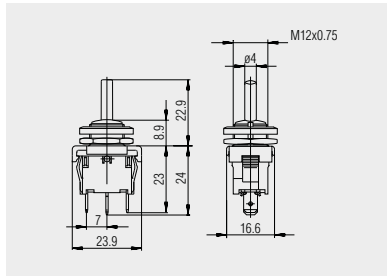

Quick-connect terminal 4.8 x 0.8 basic type 1828

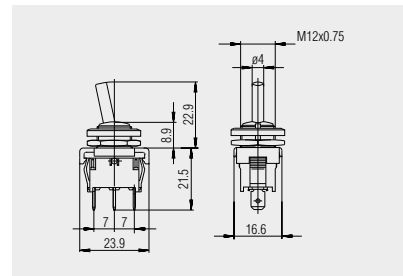

Quick-connect terminal 4.8 x 0.8 basic types 1821 and 1823

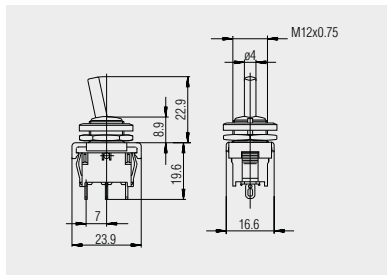

Solder terminal 1821.6101 and 1823.6101



Basic types 1822, 1824 and 1829 double-pole

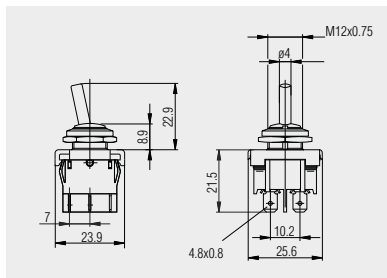

Quick-connect terminal 4.8 x 0.8 basic type 1822 and 1824

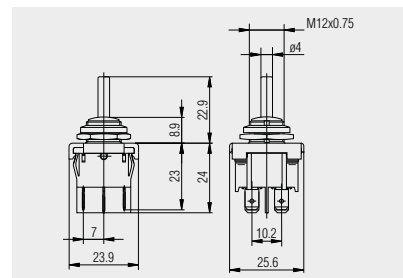

Quick-connect terminal 4.8 x 0.8 basic type 1829



Identification plate 240.001.011

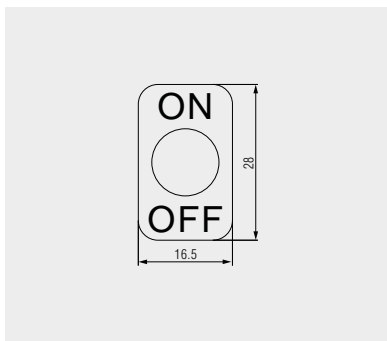

Aluminum identification plate to plugging on and with black inscription "ON" and "OFF"

ROCKER SWITCHES

PUSHBUTTON SWITCHES

TOGGLE SWITCHES

SLIDE SWITCHES

ROTARY SWITCHES

FOOT SWITCHES

TACT AND KEY SWITCHES

SNMP-ACTION SWITCHES

MICRO-SIGNAL SWITCHES

SENSORS

ECO

PUSH-IN DRIVE



SERIES 1820 - SINGLE AND DOUBLE-POLE TOGGLE SWITCHES

TO 6 (4) A 250 V AC



Identification plate
240.002.011

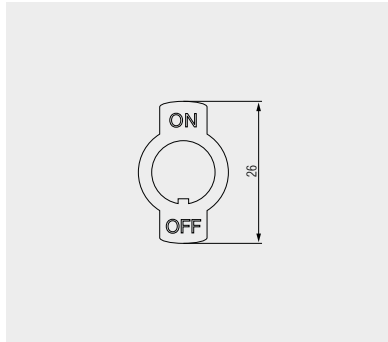

Identification plate made of CuZn nickel-plated for plugging on as well as with twist protection and stamped inscription "ON" and "OFF"



Protection cap
343.001.013 - green
343.001.023 - black
343.001.033 - red

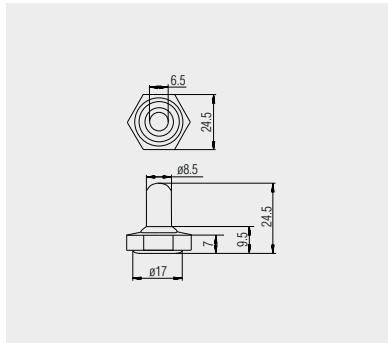

Neopren®-cap for screwing on (M12 x 0.75) to levers of the series 1820 for dust and water protection of the actuator side



Lever receptacle
203.105.011 - black
203.105.021 - white
203.105.031 - red
203.105.041 - green

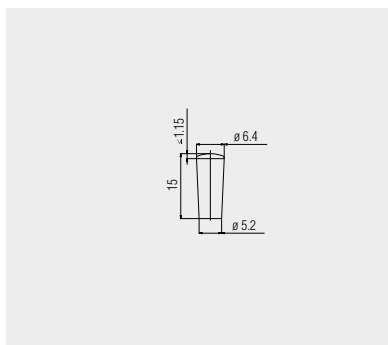

Lever receptacle in various colors for the plastic levers of the 1820 series for customer assembly. Serves as a design element and for distinguishing and marking.

MARQUARDT INTERNATIONAL.



HEADQUARTERS

Marquardt Mechatronik GmbH

Schloss-Straße 16
78604 Rietheim-Weilheim / GERMANY
Tel. +49 (0)74 24/99-0
Fax +31 (0)74 24/99-2399
marquardt@marquardt.com
www.marquardt.com

Geuken



DISTRIBUTOR

GEUKEN B.V.

Wattstraat 25a
2723 RA Zoetermeer / NETHERLANDS
Tel. +31 (0)79 361 60 70
Fax +31 (0)79 361 40 90
info@geuken.nl
www.geuken.nl